



# AMATI

CATÁLOGO DE ACCESORIOS

# AMATI

## Anilla redonda



**MATERIAL:** Latón

**COLOR:** Dorado

**APLIACIÓN:** Anilla redonda, también conocida como Arganeo, la cual sirve para unir el ancla con la cadena.

MODELO	MEDIDAS – mm		PRESENTACIÓN
	“d”	“d1”	
AMT-4000-02	2	1	Paquete de 100 pzs
AMT-4000-03	3	2	Paquete de 100 pzs
AMT-4000-04	4	3	Paquete de 100 pzs
AMT-4000-05	5	4	Paquete de 50 pzs

## Anilla cuadrada

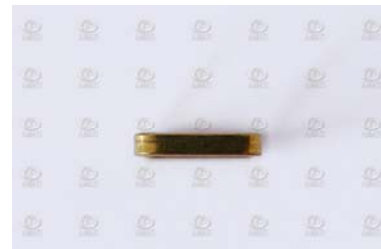
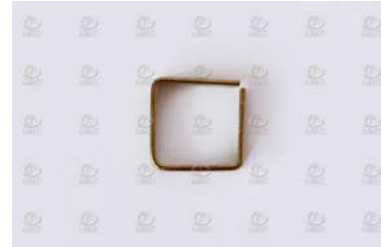

<b>MATERIAL:</b>	Latón
<b>COLOR:</b>	Dorado
<b>APLICACIÓN:</b>	Anillas de presión para el cepo – soporte de madera para el ancla

MODELO	MEDIDAS – mm		PRESENTACIÓN
	“L”	“L1”	
AMT-4004-25	3.5	2.5	Paquete de 10 pzs
AMT-4004-35	4.5	3.5	Paquete de 10 pzs
AMT-4004-40	5	4	Paquete de 10 pzs
AMT-4004-50	6	5	Paquete de 10 pzs
AMT-4004-60	7	6	Paquete de 10 pzs
AMT-4004-70	8	7	Paquete de 10 pzs

## Anilla con gancho



**MATERIAL:** Latón

**COLOR:** Dorado

**APLICACIÓN:** Anillas que se pueden insertar en la borda del barco, para amarrar y detener cabos y/o tensores

MODELO	MEDIDAS – mm		PRESENTACIÓN
	“L”	“d”	
AMT-4005-03	7	3	Paquete de 20 pzs
AMT-4005-04	8	4	Paquete de 20 pzs

## Gancho



**MATERIAL:** Latón

**COLOR:** Dorado

**APLIACIÓN:** Sirve para agarrar o colgar.

MODELO	MEDIDAS – mm		PRESENTACIÓN
	“L”	“H”	
AMT-4008	4	7	Paquete de 100 pzs

## Mosquetón



**MATERIAL:** Latón

**COLOR:** Dorado

**APLIACIÓN:** Sirve para enganchar cuerdas.

MODELO	MEDIDAS – mm		PRESENTACIÓN
	“L”	“H”	
AMT-4009-07	2	8	Paquete de 50 pzs

## Ancla antigua



**MATERIAL:** Zamak

**COLOR:** Negro

**APLICACIÓN:** Instrumento en forma de arpón o anzuelo doble que se arroja al fondo del mar para sujetar la nave

MODELO	MEDIDAS – mm			PRESENTACIÓN
	“L”	“L1”	“H”	
AMT-4010-20	20	15	20	Paquete de 2 pzs
AMT-4010-30	30	21	30	Paquete de 2 pzs

## Ancla antigua

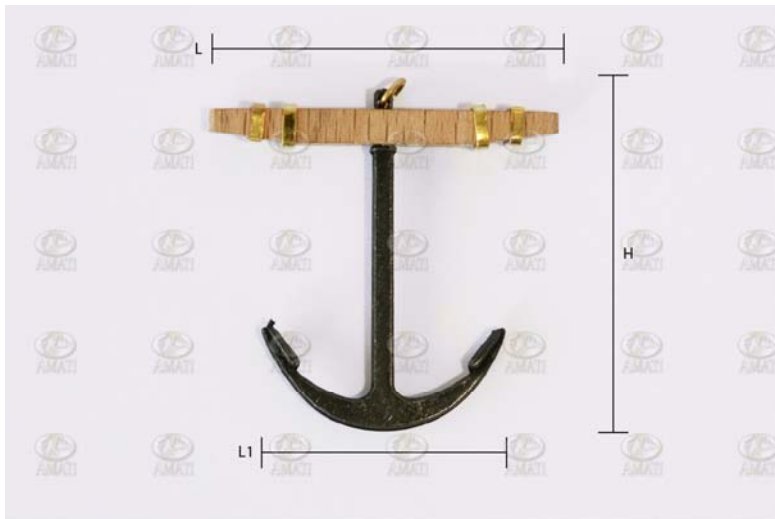

**MATERIAL:** Zamak

**COLOR:** Negro

**APLICACIÓN:** Instrumento en forma de arpón o anzuelo doble que se arroja al fondo del mar para sujetar la nave

MODELO	MEDIDAS – mm			PRESENTACIÓN
	“L”	“L1”	“H”	
AMT-4010-40	40	28	40	Paquete de 2 pzs
AMT-4010-50	50	35	50	Paquete de 2 pzs



## Ancla francesa



**MATERIAL:** Zamak

**COLOR:** Negro

**APLICACIÓN:** Instrumento en forma de arpón o anzuelo doble que se arroja al fondo del mar para sujetar la nave

MODELO	MEDIDAS – mm			PRESENTACIÓN
	“L”	“L1”	“H”	
AMT-4012-35	35	21	35	Paquete de 2 pzs

## Ancla española



**MATERIAL:** Zamak

**COLOR:** Negro

**APLICACIÓN:** Instrumento en forma de arpón o anzuelo doble que se arroja al fondo del mar para sujetar la nave

MODELO	MEDIDAS – mm			PRESENTACIÓN
	“L”	“L1”	“H”	
AMT-4015-20	20	14	20	Paquete de 2 pzs

## Ancla española



**MATERIAL:** Zamak

**COLOR:** Negro

**APLICACIÓN:** Instrumento en forma de arpón o anzuelo doble que se arroja al fondo del mar para sujetar la nave

MODELO	MEDIDAS – mm			PRESENTACIÓN
	“L”	“L1”	“H”	
AMT-4015-30	30	20	30	Paquete de 2 pzs
AMT-4015-40	40	26	40	Paquete de 2 pzs
AMT-4015-50	50	33	50	Paquete de 2 pzs

## Ancla almirantazgo



**MATERIAL:** Zamak

**COLOR:** Negro

**APLICACIÓN:** Instrumento en forma de arpón o anzuelo doble que se arroja al fondo del mar para sujetar la nave. Se distingue por su agarre en fondo duro de arcilla, arena y con algas

MODELO	MEDIDAS – mm				PRESENTACIÓN
	“L”	“L1”	“L2”	“H”	
AMT-4020-20	15	3	18	20	Paquete de 2 pzs

## Ancla almirantazgo

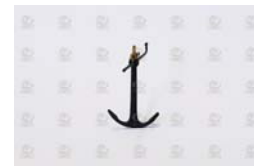

**MATERIAL:** Zamak

**COLOR:** Negro

**APLICACIÓN:** Instrumento en forma de arpón o anzuelo doble que se arroja al fondo del mar para sujetar la nave. Se distingue por su agarre en fondo duro de arcilla, arena y con algas

MODELO	MEDIDAS – mm			PRESENTACIÓN
	“L”	“L1”	“H”	
AMT-4020-30	20	4	30	Paquete de 2 pzs
AMT-4020-40	28	5	40	Paquete de 2 pzs
AMT-4020-50	35	6	50	Paquete de 2 pzs

## Ancla hall



**MATERIAL:** Zamak

**COLOR:** Negro

**APLICACIÓN:** Instrumento en forma de arpón o anzuelo doble, que se arroja al fondo del mar para sujetar la nave. Es el ancla con grilletes más utilizada para buques

MODELO	MEDIDAS – mm			PRESENTACIÓN
	“L”	“L1”	“H”	
AMT-4025-20	16	15	20	Paquete de 2 pzs
AMT-4025-30	21	20	30	Paquete de 2 pzs
AMT-4025-40	24	23	40	Paquete de 2 pzs
AMT-4025-50	30	29	50	Paquete de 2 pzs

## Ancla danforth



**MATERIAL:** Zamak

**COLOR:** Negro

**APLICACIÓN:** Instrumento en forma de arpón o anzuelo doble que se arroja al fondo del mar para sujetar la nave. El ancla consiste en dos grandes uñas planas que se mueven 30° respecto a la caña

MODELO	MEDIDAS – mm			PRESENTACIÓN
	“L”	“L1”	“H”	
AMT-4026-40	20	15	40	Paquete de 2 pzs
AMT-4026-60	30	25	60	Paquete de 2 pzs

## Columna



**MATERIAL:** Madera de Boj

**COLOR:** Natural

MODELO	MEDIDAS – mm		PRESENTACIÓN
	“H”	“d”	
AMT-4030-06	6	2	Paquete de 50 pzs
AMT-4030-08	8	3	Paquete de 50 pzs
AMT-4030-11	11	4	Paquete de 50 pzs
AMT-4030-15	15	5	Paquete de 25 pzs
AMT-4030-18	18	6	Paquete de 25 pzs



## Columna

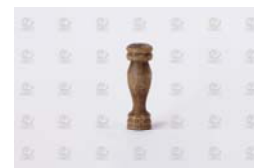
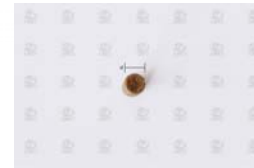

**MATERIAL:** Madera de Nogal

**COLOR:** Natural

MODELO	MEDIDAS – mm		PRESENTACIÓN
	“H”	“d”	
AMT-4035-06	6	2.5	Paquete de 50 pzs
AMT-4035-08	8	3	Paquete de 50 pzs
AMT-4035-11	11	3.5	Paquete de 50 pzs

## Columna



**MATERIAL:** Madera de Nogal

**COLOR:** Natural

MODELO	MEDIDAS – mm		PRESENTACIÓN
	“H”	“d”	
AMT-4035-12	12	4	Paquete de 25 pzs

## Columna



**MATERIAL:** Madera de Nogal

**COLOR:** Natural

MODELO	MEDIDAS – mm		PRESENTACIÓN
	“H”	“d”	
AMT-4035-17	17	4.5	Paquete de 25 pzs

## Columna



**MATERIAL:** Madera de Nogal

**COLOR:** Natural

MODELO	MEDIDAS – mm		PRESENTACIÓN
	“H”	“d”	
AMT-4035-27	27	5	Paquete de 25 pzs

## Columna



**MATERIAL:** Madera de Nogal

**COLOR:** Natural

MODELO	MEDIDAS – mm		PRESENTACIÓN
	“H”	“d”	
AMT-4035-29	29	5.5	Paquete de 25 pzs

## Tensor

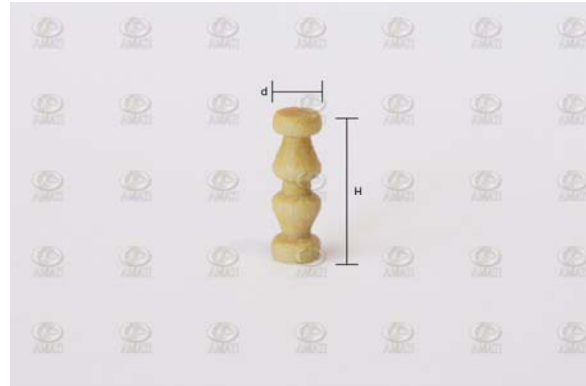

**MATERIAL:** Madera de Boj

**COLOR:** Natural

MODELO	MEDIDAS – mm		PRESENTACIÓN
	“H”	“d”	
AMT-4048	7	2.5	Paquete de 25 pzs

## Vigota



**MATERIAL:** Madera de Nogal

**COLOR:** Natural

MODELO	MEDIDAS – mm		PRESENTACIÓN
	“A”	“d”	
AMT-4049-02	2	2.5	Paquete de 50 pzs

## Vigota



**MATERIAL:** Madera de Nogal

**COLOR:** Natural

**APLICACIÓN:** Especie de motón chato y redondo, con dos o tres agujeros, por donde pasan los cabos para tensar la jarcia firme de un barco

MODELO	MEDIDAS – mm		PRESENTACIÓN
	“A”	“d”	
AMT-4050-03	2.5	3	Paquete de 50 pzs
AMT-4050-05	3	5	Paquete de 50 pzs
AMT-4050-07	3.5	7	Paquete de 50 pzs
AMT-4050-09	4	9	Paquete de 25 pzs



## Vigota



- MATERIAL:** Madera de Boj
- COLOR:** Natural
- APLICACIÓN:** Especie de motón chato y redondo, con dos o tres agujeros, por donde pasan los cabos para tensar la jarcia firme de un barco

MODELO	MEDIDAS – mm		PRESENTACIÓN
	“A”	“d”	
AMT-4055-03	2.5	3	Paquete de 50 pzs
AMT-4055-05	3	5	Paquete de 50 pzs
AMT-4055-07	3.5	7	Paquete de 50 pzs

## Vigota triangular



**MATERIAL:** Madera de Nogal

**COLOR:** Natural

**APLICACIÓN:** Especie de motón chato y redondo, con dos o tres agujeros, por donde pasan los cabos para tensar la jarcia firme de un barco

MODELO	MEDIDAS – mm		PRESENTACIÓN
	“A”	“L”	
AMT-4060-05	2.5	5	Paquete de 50 pzs
AMT-4060-07	3	7	Paquete de 50 pzs

## Vigota ciega



**MATERIAL:** Madera de Balsa

**COLOR:** Natural

MODELO	MEDIDAS – mm			PRESENTACIÓN
	“A”	“L”	“H”	
AMT-4061	3	6	8	Paquete de 10 pzs
AMT-4062	4	8	10	Paquete de 10 pzs

## Motón sencillo

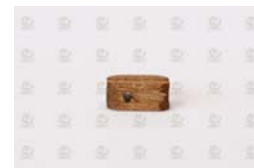
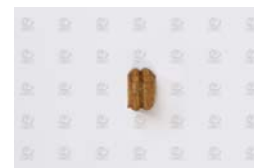

**MATERIAL:** Madera de Nogal

**COLOR:** Natural

**APLICACIÓN:** Polea de diversas formas y tamaños, por donde pasan los cabos

MODELO	MEDIDAS – mm			PRESENTACIÓN
	“A”	“L”	“H”	
AMT-4070-02	1.5	1	2	Paquete de 50 pzs
AMT-4070-03	2	2	3	Paquete de 50 pzs
AMT-4070-05	2.5	3	5	Paquete de 50 pzs
AMT-4070-07	3	4	7	Paquete de 50 pzs

## Motón doble

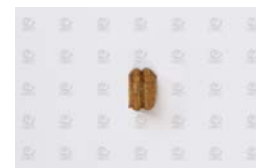

**MATERIAL:** Madera de Nogal

**COLOR:** Natural

**APLICACIÓN:** Polea doble, por donde pasan los cabos

MODELO	MEDIDAS – mm			PRESENTACIÓN
	“A”	“L”	“H”	
AMT-4080-04	2	3	4	Paquete de 50 pzs
AMT-4080-06	2.5	5	6	Paquete de 50 pzs

## Motón triple

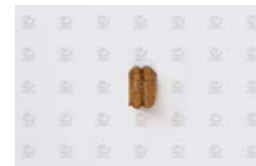

**MATERIAL:** Madera de Nogal

**COLOR:** Natural

**APLICACIÓN:** Polea triple, por donde pasan los cabos

MODELO	MEDIDAS – mm			PRESENTACIÓN
	“A”	“L”	“H”	
AMT-4083-05	4.5	3	5	Paquete de 25 pzs
AMT-4083-07	5	4	7	Paquete de 25 pzs

## Motón triple



**MATERIAL:** Madera de Balsa

**COLOR:** Natural

**APLICACIÓN:** Polea triple, por donde pasan los cabos

MODELO	MEDIDAS – mm			PRESENTACIÓN
	“A”	“L”	“H”	
AMT-4085-07	5	5	7	Paquete de 10 pzs
AMT-4085-10	6	7	10	Paquete de 10 pzs

## Motón simple

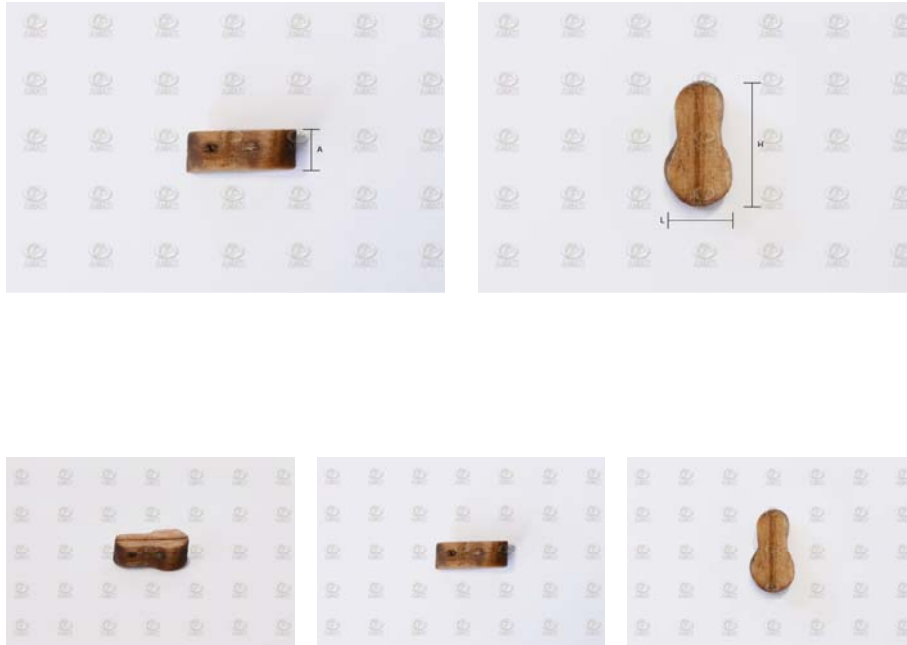

**MATERIAL:** Madera de Nogal

**COLOR:** Natural

**APLICACIÓN:** Polea de diversas formas y tamaños, por donde pasan los cabos

MODELO	MEDIDAS – mm			PRESENTACIÓN
	“A”	“L”	“H”	
AMT-4086-07	3	3	7	Paquete de 25 pzs
AMT-4086-10	4	5	10	Paquete de 25 pzs



## Cuadernal sencillo



**MATERIAL:** Madera de Boj

**COLOR:** Natural

**APLICACIÓN:** Conjunto de poleas paralelas de una misma armadura

MODELO	MEDIDAS – mm			PRESENTACIÓN
	“A”	“L”	“H”	
AMT-4087-02	1.5	2	2	Paquete de 100 pzs
AMT-4087-03	2	2.5	3	Paquete de 100 pzs
AMT-4087-05	2.5	3	5	Paquete de 100 pzs
AMT-4087-07	3	5	7	Paquete de 100 pzs

## Cuadernal doble



**MATERIAL:** Madera de Boj

**COLOR:** Natural

**APLICACIÓN:** Conjunto de poleas paralelas de una misma armadura

MODELO	MEDIDAS – mm			PRESENTACIÓN
	“A”	“L”	“H”	
AMT-4088-03	2	2	3	Paquete de 100 pzs
AMT-4088-05	3	3	5	Paquete de 100 pzs
AMT-4088-07	4	4	7	Paquete de 100 pzs

## Cuadernal triple



**MATERIAL:** Madera de Boj

**COLOR:** Natural

**APLICACIÓN:** Conjunto de poleas paralelas de una misma armadura

MODELO	MEDIDAS – mm			PRESENTACIÓN
	“A”	“L”	“H”	
AMT-4089-05	4	3	5	Paquete de 50 pzs
AMT-4089-07	5	4	7	Paquete de 50 pzs

## Cadenote con bigota

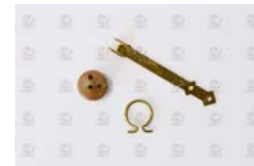

**MATERIAL:** Madera de Nogal

**COLOR:** Natural

**APLICACIÓN:** El cadenote es un tirante de hierro que sujeta las vigotas y ellas ayudan a tensar la jarcia firme de un barco

MODELO	MEDIDAS – mm		PRESENTACIÓN
	“L”	“d”	
AMT-4090-05	30	5	Paquete de 10 pzs
AMT-4090-07	35	7	Paquete de 10 pzs

## Cadenote con bigota

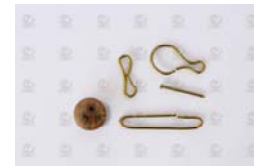
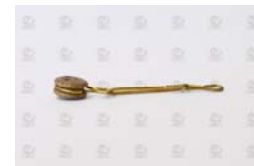

**MATERIAL:** Madera de Nogal

**COLOR:** Natural

**APLICACIÓN:** El cadenote es un tirante de hierro que sujeta las vigotas y ellas ayudan a tensar la jarcia firme de un barco

MODELO	MEDIDAS – mm		PRESENTACIÓN
	“L”	“d”	
AMT-4093-05	28	5	Paquete de 10 pzs
AMT-4093-07	36	7	Paquete de 10 pzs

## Cadenote con bigota



**MATERIAL:** Madera de Nogal

**COLOR:** Natural

**APLICACIÓN:** El cadenote es un tirante de hierro que sujeta las vigotas y ellas ayudan a tensar la jarcia firme de un barco

MODELO	MEDIDAS – mm		PRESENTACIÓN
	“L”	“d”	
AMT-4095-05	440	5	Paquete de 10 pzs
AMT-4095-07	420	7	Paquete de 10 pzs

## Cabilla



**MATERIAL:** Latón

**COLOR:** Natural

**APLICACIÓN:** Barra que pasa por el agujero de los cabilleros, que sirve para amarrar o dar vueltas a los cabos (cuerdas)

MODELO	MEDIDAS – mm		PRESENTACIÓN
	“H”	“d”	
AMT-4100-05	5	1	Paquete de 50 pzs
AMT-4100-09	8	1.5	Paquete de 50 pzs
AMT-4100-12	12	2	Paquete de 50 pzs

## Cabilla



**MATERIAL:** Latón

**COLOR:** Natural

**ACABADO:** Envejecido

**APLICACIÓN:** Barra que pasa por el agujero de los cabilleros, que sirve para amarrar o dar vueltas a los cabos (cuerdas)

MODELO	MEDIDAS – mm		PRESENTACIÓN
	“H”	“d”	
AMT-4101-07	7	2	Paquete de 50 pzs
AMT-4101-09	9	1.5	Paquete de 50 pzs
AMT-4101-12	12	2	Paquete de 50 pzs



## Cabilla



**MATERIAL:** Madera de Nogal

**COLOR:** Natural

**APLICACIÓN:** Barra que pasa por el agujero de los cabilleros, que sirve para amarrar o dar vueltas a los cabos (cuerdas)

MODELO	MEDIDAS – mm		PRESENTACIÓN
	“H”	“d”	
AMT-4104-06	6	2	Paquete de 100 pzs
AMT-4104-08	8	2.5	Paquete de 100 pzs
AMT-4104-10	10	2	Paquete de 100 pzs
AMT-4104-14	14	2.5	Paquete de 100 pzs
AMT-4104-16	16	3	Paquete de 50 pzs

## Cabilla



**MATERIAL:** Madera de Boj

**COLOR:** Natural

**APLICACIÓN:** Barra que pasa por el agujero de los cabilleros, que sirve para amarrar o dar vueltas a los cabos (cuerdas)

MODELO	MEDIDAS – mm		PRESENTACIÓN
	“H”	“d”	
AMT-4105-06	6	2	Paquete de 100 pzs
AMT-4105-08	8	2.5	Paquete de 100 pzs
AMT-4105-10	10	2	Paquete de 100 pzs
AMT-4105-14	14	2.5	Paquete de 100 pzs
AMT-4105-16	16	3	Paquete de 50 pzs

## Cabillero



MATERIAL:	Metal
COLOR:	Natural
ACABADO:	Envejecido
APLICACIÓN:	Pieza de madera o metal con agujeros, por donde pasan las cabillas que sirven para amarrar los cabos

MODELO	MEDIDAS – mm		PRESENTACIÓN
	“d”	“d1”	
AMT-4107	15	6	Paquete de 2 pzs

## Cabillero



**MATERIAL:** Metal

**COLOR:** Natural

**ACABADO:** Envejecido

**APLICACIÓN:** Pieza de madera o metal con agujeros, por donde pasan las cabillas que sirven para amarrar los cabos

MODELO	MEDIDAS – mm			PRESENTACIÓN
	“A”	“L”	“H”	
AMT-4107-02	17	20	12	Pieza

## Cabillero

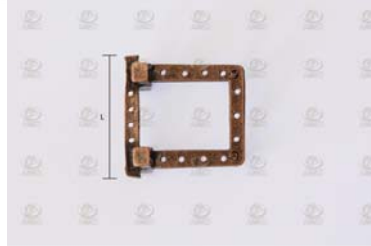

<b>MATERIAL:</b>	Metal
<b>COLOR:</b>	Natural
<b>ACABADO:</b>	Envejecido
<b>APLICACIÓN:</b>	Pieza de madera o metal con agujeros, por donde pasan las cabillas que sirven para amarrar los cabos

MODELO	MEDIDAS – mm			PRESENTACIÓN
	“A”	“L”	“H”	
AMT-4107-03	25	25	18	Pieza

## Cabrestante



**MATERIAL:** Madera de Balsa

**COLOR:** Natural

**APLICACIÓN:** Torno de madera que sirve para mover piezas de mucho peso, como por ejemplo, anclas en maniobras de fondeo

MODELO	MEDIDAS – mm		PRESENTACIÓN
	“H”	“d”	
AMT-4110-01	15	13	Paquete de 4 pzs

## Molinete horizontal



**MATERIAL:** Madera de Boj

**COLOR:** Natural

**APLICACIÓN:** Máquina empleada para virar cadenas y cabos, pudiendo ser accionada manualmente, a vapor o eléctricamente

MODELO	MEDIDAS – mm			PRESENTACIÓN
	“A”	“L”	“H”	
AMT-4115-02	7	30	14	Paquete de 2 pzs

## Molinete horizontal



**MATERIAL:** Madera de Boj

**COLOR:** Natural

**APLICACIÓN:** Máquina empleada para virar cadenas y cabos, pudiendo ser accionada manualmente, a vapor o eléctricamente

MODELO	MEDIDAS – mm			PRESENTACIÓN
	“A”	“L”	“H”	
AMT-4115-03	30	33	16	Paquete de 2 pzs



## Molinete horizontal

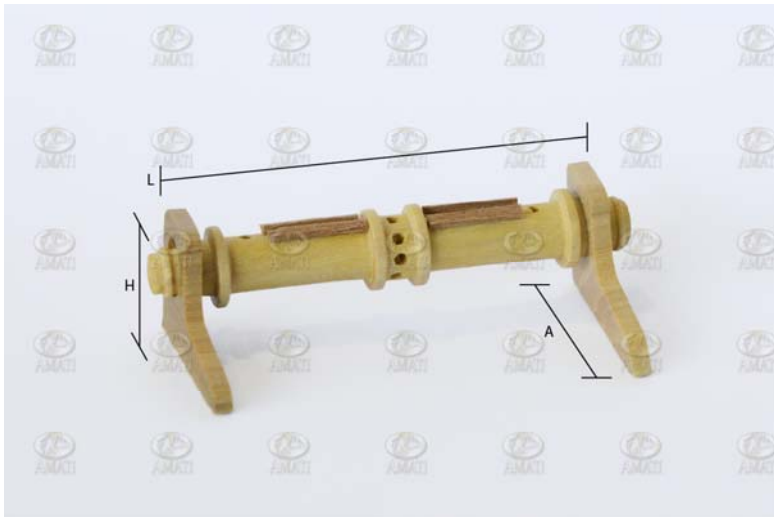

**MATERIAL:** Madera de Boj

**COLOR:** Natural

**APLICACIÓN:** Máquina empleada para virar cadenas y cabos, pudiendo ser accionada manualmente, a vapor o eléctricamente

MODELO	MEDIDAS – mm			PRESENTACIÓN
	“A”	“L”	“H”	
AMT-4115-05	25	55	15	Paquete de 2 pzs

## Cabrestante



**MATERIAL:** Madera de Boj

**COLOR:** Natural

**APLICACIÓN:** Torno de madera que sirve para mover piezas de mucho peso, por ejemplo, anclas en maniobras de fondeo

MODELO	MEDIDAS – mm		PRESENTACIÓN
	“H”	“d”	
AMT-4116-01	10	8	Paquete de 4 pzs
AMT-4116-02	16	13	Paquete de 4 pzs

## Molinete vertical

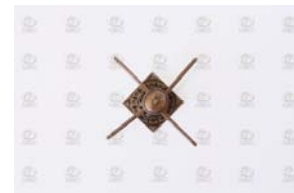

**MATERIAL:** Metal

**COLOR:** Natural

**ACABADO:** Envejecido

**APLICACIÓN:** Máquina empleada para virar cadenas y cabos, pudiendo ser accionada manualmente, a vapor o eléctricamente

MODELO	MEDIDAS – mm		PRESENTACIÓN
	“L”	“H”	
AMT-4117	20	18	Pieza

## Molinete vertical



<b>MATERIAL:</b>	Metal
<b>COLOR:</b>	Natural
<b>ACABADO:</b>	Envejecido
<b>APLICACIÓN:</b>	Máquina empleada para virar cadenas y cabos, pudiendo ser accionada manualmente, a vapor o eléctricamente

MODELO	MEDIDAS – mm		PRESENTACIÓN
	“L”	“H”	
AMT-4117-04	10	16	Paquete de 2 pzs

## Molinete horizontal



**MATERIAL:** Metal

**COLOR:** Natural

**ACABADO:** Envejecido

**APLICACIÓN:** Máquina empleada para virar cadenas y cabos, pudiendo ser accionada manualmente, a vapor o eléctricamente

MODELO	MEDIDAS – mm			PRESENTACIÓN
	“A”	“L”	“H”	
AMT-4118-01	6	20	10	Paquete de 2 pzs

## Molinete horizontal

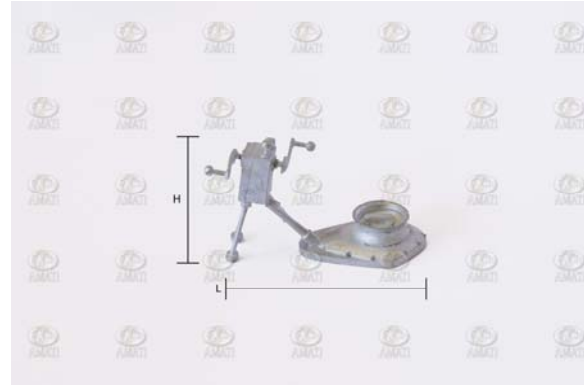

**MATERIAL:** Metal

**COLOR:** Plateado

**APLICACIÓN:** Máquina empleada para virar cadenas y cabos, pudiendo ser accionada manualmente, a vapor o eléctricamente

MODELO	MEDIDAS – mm		PRESENTACIÓN
	“L”	“H”	
AMT-4119-10	35	20	Pieza

## Barril



**MATERIAL:** Madera de Balsa

**COLOR:** Natural

**APLICACIÓN:** Almacenan líquidos y sólidos para los viajes a realizar con el navío

MODELO	MEDIDAS – mm		PRESENTACIÓN
	“H”	“d”	
AMT-4120-10	10	6	Paquete de 10 pzs
AMT-4120-16	16	10	Paquete de 10 pzs
AMT-4120-22	22	16	Paquete de 10 pzs

## Clavillas



**MATERIAL:** Madera de Boj

**COLOR:** Natural

**APLICACIÓN:** Unir dos piezas de madera y reforzar los ensamblajes de la estructura del navío

MODELO	MEDIDAS – mm	PRESENTACIÓN
	“L”	
AMT-4129	7	Paquete de 50 pzs



## Bisagras con perno

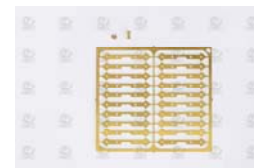
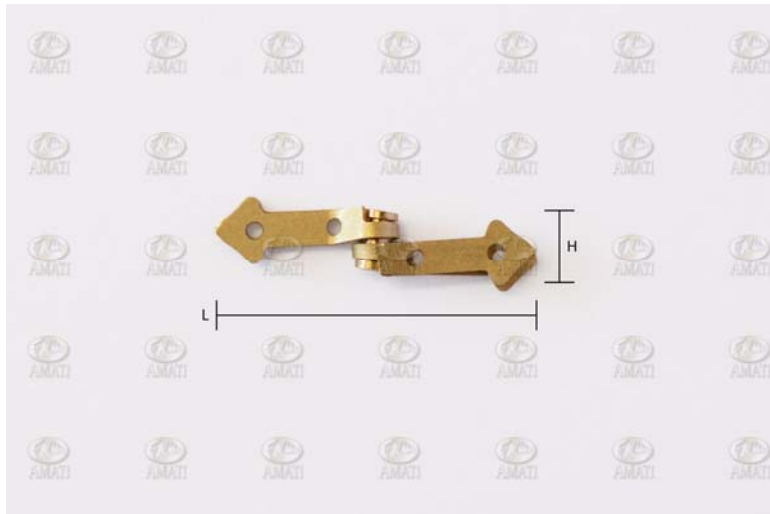

**MATERIAL:** Latón

**COLOR:** Natural

**APLICACIÓN:** Mecanismo que sirve para la apertura o cierre de una puerta, ventana o tapa o para articular dos superficies

MODELO	MEDIDAS – mm		PRESENTACIÓN
	“L”	“H”	
AMT-4131	16	3	Paquete de 20 pzs

## Puerta para cañón



MATERIAL: Metal  
 COLOR: Natural  
 ACABADO: Envejecido

MODELO	MEDIDAS – mm		PRESENTACIÓN
	“L”	“L1”	
AMT-4132-07	7	7	Paquete de 10 pzs

## Puerta para cañón



MATERIAL: Metal

COLOR: Natural

ACABADO: Envejecido

MODELO	MEDIDAS – mm		PRESENTACIÓN
	“L”	“L1”	
AMT-4132-10	10	10	Paquete de 10 pzs
AMT-4132-13	13	13	Paquete de 10 pzs
AMT-4132-18	18	18	Paquete de 10 pzs

## Punta fijadora



**MATERIAL:** Latón

**COLOR:** Natural

**APLICACIÓN:** Ayudar a sujetar dos o más objetos

MODELO	MEDIDAS – mm		PRESENTACIÓN
	“L”	“d”	
AMT-4134-31	11	0.8	Paquete de 200 pzs

## Campana

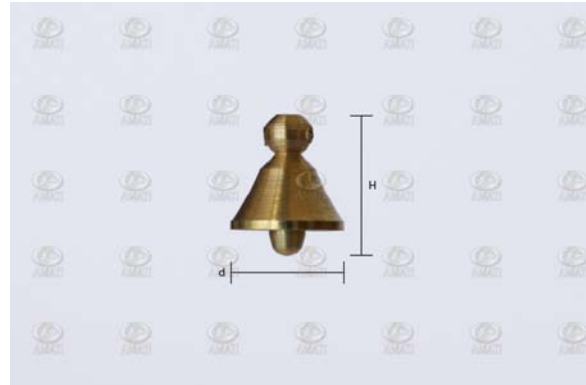

**MATERIAL:** Latón

**COLOR:** Natural

MODELO	MEDIDAS – mm		PRESENTACIÓN
	“H”	“d”	
AMT-4140-06	9	6	Paquete de 4 pzs

## Campana



**MATERIAL:** Latón

**COLOR:** Natural

MODELO	MEDIDAS – mm		PRESENTACIÓN
	“H”	“d”	
AMT-4140-09	9	9	Paquete de 4 pzs

## Campanario



**MATERIAL:** Metal

**COLOR:** Natural

**ACABADO:** Envejecido

MODELO	MEDIDAS – mm		PRESENTACIÓN
	“L”	“H”	
AMT-4141	16	23	Pieza

## Campanario



**MATERIAL:** Metal

**COLOR:** Natural

**ACABADO:** Envejecido

MODELO	MEDIDAS – mm		PRESENTACIÓN
	“L”	“H”	
AMT-4141-02	11	10	Paquete de 2 pzs



## Campana



**MATERIAL:** Latón

**COLOR:** Natural

MODELO	MEDIDAS – mm		PRESENTACIÓN
	“H”	“d”	
AMT-4142	10	14	Paquete de 2 pzs

## Cubeta



**MATERIAL:** Latón

**COLOR:** Natural

MODELO	MEDIDAS – mm		PRESENTACIÓN
	“H”	“d”	
AMT-4143-03	3	3	Paquete de 10 pzs

## Cubeta



**MATERIAL:** Metal

**COLOR:** Negro

MODELO	MEDIDAS – mm		PRESENTACIÓN
	“H”	“d”	
AMT-4144-05	6	5	Paquete de 10 pzs

## Cubeta



**MATERIAL:** Metal

**COLOR:** Negro

MODELO	MEDIDAS – mm		PRESENTACIÓN
	“H”	“d”	
AMT-4144-06	6	5	Paquete de 4 pzs

## Cubeta



**MATERIAL:** Metal

**COLOR:** Natural

**ACABADO:** Envejecido

MODELO	MEDIDAS – mm		PRESENTACIÓN
	“H”	“d”	
AMT-4144-10	10	8	Paquete de 4 pzs

## Cubeta



**MATERIAL:** Madera de Boj

**COLOR:** Natural

MODELO	MEDIDAS – mm		PRESENTACIÓN
	“H”	“d”	
AMT-4145-09	9	8	Paquete de 4 pzs
AMT-4145-12	12	12	Paquete de 4 pzs

## Cubeta



**MATERIAL:** Madera de Nogal

**COLOR:** Natural

MODELO	MEDIDAS – mm			PRESENTACIÓN
	“H”	“H”	“d”	
AMT-4146-08	14	8	8	Paquete de 5 pzs

## Tina



**MATERIAL:** Metal

**COLOR:** Plateado

MODELO	MEDIDAS – mm		PRESENTACIÓN
	“H”	“d”	
AMT-4148-01	15	15	Pieza



## Falconeta



**MATERIAL:** Latón

**COLOR:** Natural

**APLICACIÓN:** Pieza pequeña de artillería, que se monta en la cubierta y sirve cuando se hace un desembarco, también se les conoce como culebrinas

MODELO	MEDIDAS – mm		PRESENTACIÓN
	“L”	“H”	
AMT-4150-03	22	7	Paquete de 4 pzs
AMT-4150-04	32	10	Paquete de 4 pzs

## Falconeta



**MATERIAL:** Metal

**COLOR:** Plateado

**APLICACIÓN:** Pieza pequeña de artillería, que se monta en la cubierta y sirve cuando se hace un desembarco, también se les conoce como culebrinas

MODELO	MEDIDAS – mm		PRESENTACIÓN
	“L”	“H”	
AMT-4151-01	24	25	Paquete de 10 pzs

## Cañón con carro



MATERIAL: Metal

COLOR: Natural

ACABADO: Envejecido

MODELO	MEDIDAS – mm			PRESENTACIÓN
	“A”	“L”	“H”	
AMT-4155-20	13	20	10	Paquete de 2 pzs
AMT-4155-30	16	30	12	Paquete de 2 pzs
AMT-4155-40	18	40	15	Paquete de 2 pzs

## Cañón con carro



MATERIAL: Metal

COLOR: Natural

ACABADO: Envejecido

MODELO	MEDIDAS – mm			PRESENTACIÓN
	“A”	“L”	“H”	
AMT-4159-30	15	30	18	Paquete de 2 pzs
AMT-4159-40	16	40	18	Paquete de 2 pzs
AMT-4159-50	20	50	26	Paquete de 2 pzs

## Cañón con carro

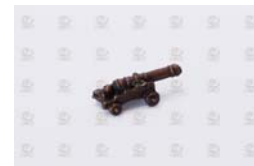

MATERIAL: Metal

COLOR: Natural

ACABADO: Envejecido

MODELO	MEDIDAS – mm			PRESENTACIÓN
	“A”	“L”	“H”	
AMT-4160-15	8	15	5	Paquete de 2 pzs

## Cañón con carro



MATERIAL: Metal

COLOR: Natural

ACABADO: Envejecido

MODELO	MEDIDAS – mm			PRESENTACIÓN
	“A”	“L”	“H”	
AMT-4160-20	12	20	10	Paquete de 2 pzs

## Cañón con carro



MATERIAL: Metal

COLOR: Natural

ACABADO: Envejecido

MODELO	MEDIDAS – mm			PRESENTACIÓN
	“A”	“L”	“H”	
AMT-4161	15	30	11	Paquete de 2 pzs

## Cañón con carro



MATERIAL: Metal

COLOR: Natural

ACABADO: Envejecido

MODELO	MEDIDAS – mm			PRESENTACIÓN
	“A”	“L”	“H”	
AMT-4162	20	40	16	Paquete de 2 pzs



## Cañón



**MATERIAL:** Metal

**COLOR:** Natural

**ACABADO:** Envejecido

MODELO	MEDIDAS – mm		PRESENTACIÓN
	“L”	“d”	
AMT-4164-18	18	3	Paquete de 10 pzs
AMT-4164-27	27	4	Paquete de 10 pzs
AMT-4164-38	38	5	Paquete de 10 pzs

## Cañón



MATERIAL: Latón

COLOR: Natural

MODELO	MEDIDAS – mm		PRESENTACIÓN
	“L”	“d”	
AMT-4164-44	45	8	Paquete de 2 pzs

## Cañón



**MATERIAL:** Metal

**COLOR:** Natural

**ACABADO:** Envejecido

MODELO	MEDIDAS – mm		PRESENTACIÓN
	“L”	“d”	
AMT-4164-45	45	6	Paquete de 2 pzs

## Cañón



**MATERIAL:** Latón

**COLOR:** Natural

MODELO	MEDIDAS – mm		PRESENTACIÓN
	“L”	“d”	
AMT-4164-65	65	13	Paquete de 2 pzs

## Cañón



**MATERIAL:** Latón

**COLOR:** Natural

MODELO	MEDIDAS – mm		PRESENTACIÓN
	“L”	“d”	
AMT-4165-30	30	5	Paquete de 10 pzs

## Cañón



**MATERIAL:** Metal

**COLOR:** Negro

**ACABADO:** Envejecido

MODELO	MEDIDAS – mm		PRESENTACIÓN
	“L”	“d”	
AMT-4167	20	3	Paquete de 2 pzs

## Cañón

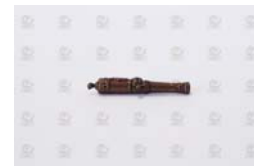

**MATERIAL:** Metal

**COLOR:** Natural

**ACABADO:** Envejecido

MODELO	MEDIDAS – mm		PRESENTACIÓN
	“L”	“d”	
AMT-4168	27	4	Paquete de 2 pzs
AMT-4169	36	5	Paquete de 2 pzs

## Falso cañón



**MATERIAL:** Metal

**COLOR:** Natural

**ACABADO:** Envejecido

MODELO	MEDIDAS – mm		PRESENTACIÓN
	“L”	“d”	
AMT-4172-15	15	4	Paquete de 10 pzs
AMT-4172-17	17	4.5	Paquete de 10 pzs
AMT-4172-21	21	5	Paquete de 10 pzs



## Falso cañón



**MATERIAL:** Latón

**COLOR:** Natural

MODELO	MEDIDAS – mm		PRESENTACIÓN
	“L”	“d”	
AMT-4175-12	12	5	Paquete de 10 pzs
AMT-4175-15	15	5.5	Paquete de 10 pzs
AMT-4175-17	17	6	Paquete de 10 pzs

## Soporte para cañón

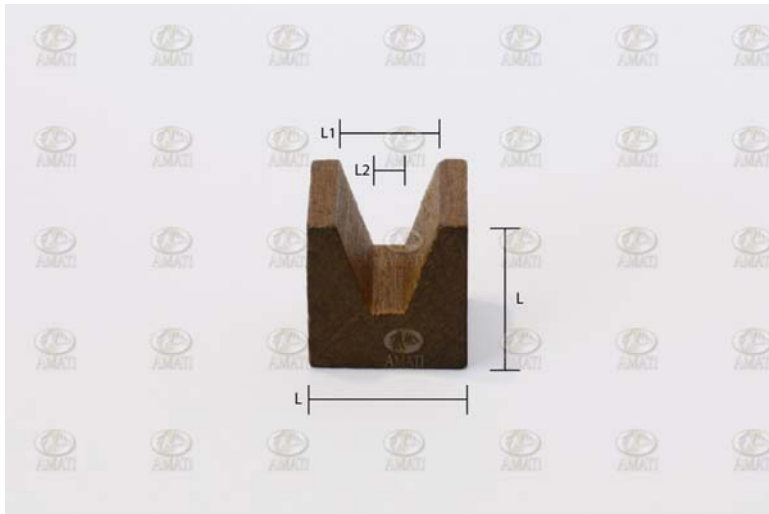

**MATERIAL:** Madera de nogal

**COLOR:** Natural

MODELO	MEDIDAS – mm				PRESENTACIÓN
	“A”	“L”	“L1”	“L2”	
AMT-4176	14	14	8	2	Paquete de 10 pzs

## Cañón tipo carronada



**MATERIAL:** Latón

**COLOR:** Natural

MODELO	MEDIDAS – mm		PRESENTACIÓN
	“L”	“d”	
AMT-4178-20	20	6	Pieza
AMT-4178-26	26	9	Pieza
AMT-4178-35	35	10	Pieza

## Cañón tipo carronada



MATERIAL: Metal

COLOR: Natural

ACABADO: Envejecido

MODELO	MEDIDAS – mm		PRESENTACIÓN
	“L”	“d”	
AMT-4178-50	50	6	Paquete de 2 pzs

## Carro para carronada

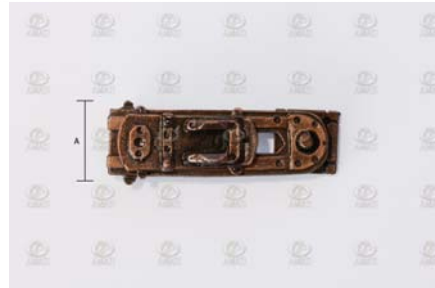

MATERIAL: Metal

COLOR: Natural

ACABADO: Envejecido

MODELO	MEDIDAS – mm			PRESENTACIÓN
	“A”	“L”	“H”	
AMT-4179-20	12	20	8	Pieza
AMT-4179-26	13	26	11	Pieza
AMT-4179-35	17	35	13	Pieza

## Tubo de mortero



**MATERIAL:** Metal

**COLOR:** Negro

**ACABADO:** Envejecido

MODELO	MEDIDAS – mm			PRESENTACIÓN
	“L”	“H”	“d”	
AMT-4180-01	14	8	8	Paquete de 2 pzs

## Tubo de mortero



**MATERIAL:** Metal

**COLOR:** Natural

**ACABADO:** Envejecido

MODELO	MEDIDAS – mm			PRESENTACIÓN
	“L”	“H”	“d”	
AMT-4180-02	18	12	10	Paquete de 2 pzs
AMT-4180-03	25	18	13	Paquete de 2 pzs

## Cañón español



**MATERIAL:** Metal

**COLOR:** Natural

**ACABADO:** Envejecido

MODELO	MEDIDAS – mm			PRESENTACIÓN
	“L”	“H”	“d”	
AMT-4185-22	22	8	4	Paquete de 2 pzs
AMT-4185-32	32	9	4	Paquete de 2 pzs



## Cañón español con carro

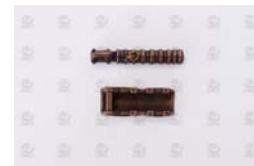

MATERIAL: Metal

COLOR: Natural

ACABADO: Envejecido

MODELO	MEDIDAS – mm			PRESENTACIÓN
	“A”	“L”	“H”	
AMT-4190-22	6	22	4	Paquete de 2 pzs
AMT-4190-32	8	32	6	Paquete de 2 pzs

## Bala de cañón



**MATERIAL:** Metal

**COLOR:** Natural

MODELO	MEDIDAS – mm	PRESENTACIÓN
	“d”	
AMT-4195-15	1.5	Paquete de 100 pzs
AMT-4195-20	2	Paquete de 100 pzs
AMT-4195-25	2.5	Paquete de 100 pzs
AMT-4195-30	3	Paquete de 100 pzs

## Tronera



<b>MATERIAL:</b>	Metal
<b>COLOR:</b>	Natural
<b>ACABADO:</b>	Envejecido
<b>APLICACIÓN:</b>	Agujeros que se practican en los parapetos y partes de un buque corsario o mercante, para hacer fuero por ellos al enemigo en el acto de aborda

MODELO	MEDIDAS – mm	PRESENTACIÓN
	“L”	
AMT-4240-08	8	Paquete de 10 pzs
AMT-4240-10	10	Paquete de 10 pzs
AMT-4240-13	13	Paquete de 10 pzs

## Puerta antigua



**MATERIAL:** Metal

**COLOR:** Natural

MODELO	MEDIDAS – mm		PRESENTACIÓN
	“L”	“H”	
AMT-4250-01	7	10	Paquete de 10 pzs
AMT-4250-02	10	15	Paquete de 10 pzs

## Puerta antigua

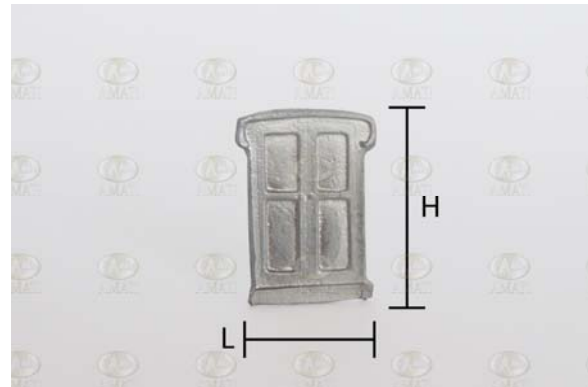

**MATERIAL:** Metal

**COLOR:** Natural

MODELO	MEDIDAS – mm		PRESENTACIÓN
	“L”	“H”	
AMT-4250-03	8	25	Paquete de 10 pzs

## Puerta antigua



**MATERIAL:** Metal

**COLOR:** Natural

**ACABADO:** Envejecido

MODELO	MEDIDAS – mm		PRESENTACIÓN
	“L”	“H”	
AMT-4250-18	12	18	Paquete de 10 pzs

## Cornamusa



**MATERIAL:** Madera de Nogal

**COLOR:** Natural

**APLICACIÓN:** Sirve para amarrar cabos, clavándolo por su centro en cubierta o costados

MODELO	MEDIDAS – mm		PRESENTACIÓN
	“L”	“H”	
AMT-4270	12	5	Paquete de 25 pzs

## Rueda para cañón



**MATERIAL:** Madera de Nogal

**COLOR:** Natural

MODELO	MEDIDAS – mm		PRESENTACIÓN
	“d”	“d1”	
AMT-4271-04	4	2	Paquete de 20 pzs
AMT-4271-05	5	2	Paquete de 20 pzs
AMT-4271-06	6	2	Paquete de 20 pzs



## Polea



**MATERIAL:** Madera de boj

**COLOR:** Natural

MODELO	MEDIDAS – mm		PRESENTACIÓN
	“d”	“d1”	
AMT-4280-25	2.5	1	Paquete de 10 pzs
AMT-4280-35	3.5	2	Paquete de 10 pzs
AMT-4280-50	5	1.5	Paquete de 10 pzs

## Escudo vikingo



**MATERIAL:** Metal

**COLOR:** Natural

**ACABADO:** Envejecido

MODELO	MEDIDAS – mm	PRESENTACIÓN
	“d”	
AMT-4290	20	Paquete de 10 pzs

## Cornamusa



**MATERIAL:** Madera de balsa

**COLOR:** Natural

**APLICACIÓN:** Es la punta en que remata el remo por el extremo opuesto a la pala y por donde se agarra para remar, también se usa para amarrar cabos en las bordas de los barcos

MODELO	MEDIDAS – mm		PRESENTACIÓN
	“L”	“H”	
AMT-4291	12	9	Paquete de 20 pzs

## Ventana antigua



**MATERIAL:** Metal

**COLOR:** Natural

**ACABADO:** Envejecido

MODELO	MEDIDAS – mm		PRESENTACIÓN
	“L”	“H”	
AMT-4292	13	18	Paquete de 4 pzs

## Celosía para ventana



**MATERIAL:** Latón

**COLOR:** Plateado

**APLICACIÓN:** Es el enrejado de listoncillos de madera o hierro, que se pone en las ventanas de los barcos, para que las personas del interior vean sin ser vistas

MODELO	MEDIDAS - mm		PRESENTACIÓN
	"L"	"H"	
AMT-4293	100	50	Paquete de 2 pzs

## Tina



**MATERIAL:** Madera de balsa

**COLOR:** Natural

**APLICACIÓN:** Meseta colocada horizontalmente en el cuello de un palo, facilitando la maniobra de velas altas; colocar vigías durante la navegación

MODELO	MEDIDAS – mm			PRESENTACIÓN
	“H”	“d”	“d1”	
AMT-4294	10	15	13	Paquete de 2 pzs

## Tina



**MATERIAL:** Madera de nogal

**COLOR:** Natural

**APLICACIÓN:** Meseta colocada horizontalmente en el cuello de un palo, facilitando la maniobra de velas altas; colocar vigías durante la navegación

MODELO	MEDIDAS – mm				PRESENTACIÓN
	“H”	“d”	“d1”	“d2”	
AMT-4294-01	12	26	19	4	Paquete de 2 pzs
AMT-4294-02	19	40	30	7	Paquete de 2 pzs

## Tina



**MATERIAL:** Madera de nogal

**COLOR:** Natural

**APLICACIÓN:** Meseta colocada horizontalmente en el cuello de un palo, facilitando la maniobra de velas altas; colocar vigías durante la navegación

MODELO	MEDIDAS – mm			PRESENTACIÓN
	“H”	“d”	“d1”	
AMT-4294-03	12	60	53	Paquete de 2 pzs



## Tina



**MATERIAL:** Madera de nogal

**COLOR:** Natural

**APLICACIÓN:** Meseta colocada horizontalmente en el cuello de un palo, facilitando la maniobra de velas altas; colocar vigías durante la navegación

MODELO	MEDIDAS – mm	PRESENTACIÓN
	“d”	
AMT-4294-42	42	Pieza

## Cruceta francesa



**MATERIAL:** Madera de balsa

**COLOR:** Natural

**APLICACIÓN:** Barras de madera o de metal, perpendiculares al mástil, que sirven para armarlo, descomponiendo el esfuerzo de los obenques, para que los palos mantengan su rigidez

MODELO	MEDIDAS – mm		PRESENTACIÓN
	“L”	“H”	
AMT-4295-02	25	27	Paquete de 2 pzs

## Cruceta francesa

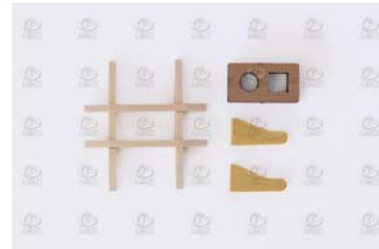
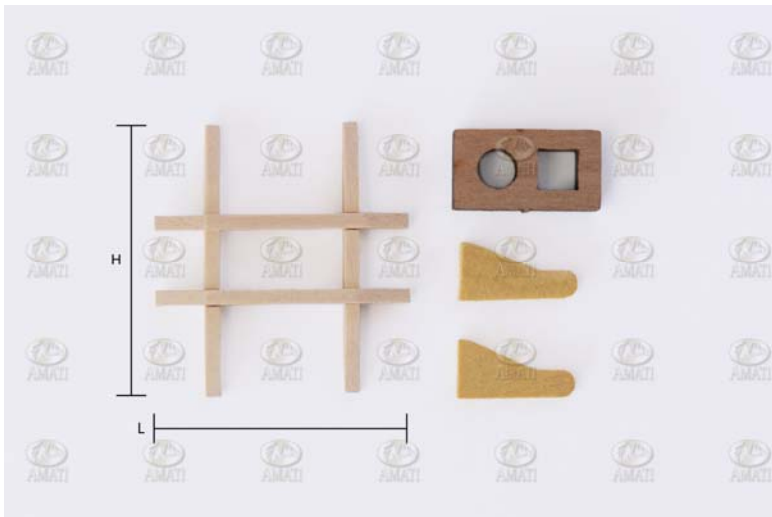

**MATERIAL:** Madera de balsa

**COLOR:** Natural

**APLICACIÓN:** Barras de madera o de metal, perpendiculares al mástil, que sirven para armarlo, descomponiendo el esfuerzo de los obenques, para que los palos mantengan su rigidez

MODELO	MEDIDAS – mm		PRESENTACIÓN
	“L”	“H”	
AMT-4296-02	25	27	Paquete de 2 pzs
AMT-4296-03	32	34	Paquete de 2 pzs

## Cabeza de mástil



**MATERIAL:** Madera de balsa

**COLOR:** Natural

MODELO	MEDIDAS – mm		PRESENTACIÓN
	“L”	“H”	
AMT-4298-02	8	13	Paquete de 2 pzs
AMT-4298-03	10	18	Paquete de 2 pzs

## Bote salvavidas

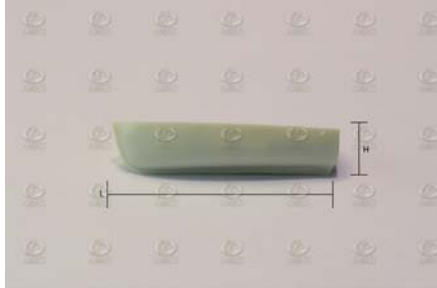

MATERIAL: Plástico

COLOR: Gris

MODELO	MEDIDAS – mm			PRESENTACIÓN
	“A”	“L”	“H”	
AMT-4300-28	10	28	6	Paquete de 2 pzs

## Bote salvavidas

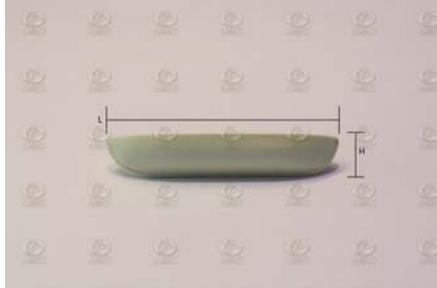

MATERIAL: Plástico

COLOR: Gris

MODELO	MEDIDAS – mm			PRESENTACIÓN
	“A”	“L”	“H”	
AMT-4300-50	14	50	8	Paquete de 2 pzs

## Bote salvavidas



**MATERIAL:** Metal

**COLOR:** Natural

MODELO	MEDIDAS – mm			PRESENTACIÓN
	“A”	“L”	“H”	
AMT-4302-07	20	70	14	Paquete de 2 pzs
AMT-4302-09	26	90	15	Paquete de 2 pzs
AMT-4302-10	30	105	19	Paquete de 2 pzs

## Bote salvavidas



**MATERIAL:** Metal

**COLOR:** Natural

**APLICACIÓN:** Bote salvavidas para carabelas del Siglo XV y Siglo XVI

MODELO	MEDIDAS – mm			PRESENTACIÓN
	“A”	“L”	“H”	
AMT-4304	24	65	13	Pieza



## Bote salvavidas

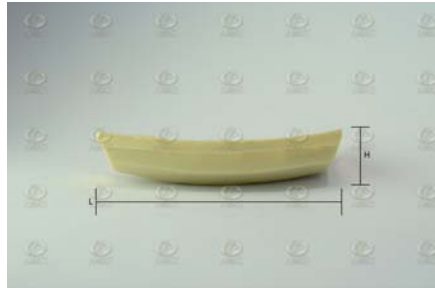

**MATERIAL:** Resina

**COLOR:** Natural

**APLICACIÓN:** Bote salvavidas estilo oriental

MODELO	MEDIDAS – mm			PRESENTACIÓN
	“A”	“L”	“H”	
AMT-4304-02	20	55	10	Paquete de 2 pzs

## Bote salvavidas

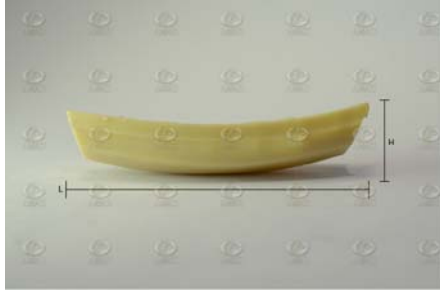

**MATERIAL:** Resina

**COLOR:** Natural

**APLICACIÓN:** Bote salvavidas estilo oriental

MODELO	MEDIDAS – mm			PRESENTACIÓN
	“A”	“L”	“H”	
AMT-4304-03	24	70	15	Paquete de 2 pzs

## Bote salvavidas

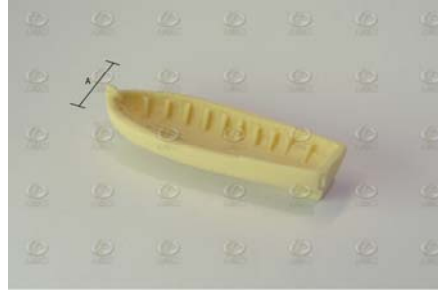

**MATERIAL:** Resina

**COLOR:** Natural

MODELO	MEDIDAS – mm			PRESENTACIÓN
	“A”	“L”	“H”	
AMT-4304-04	20	50	10	Paquete de 2 pzs

## Bote salvavidas



**MATERIAL:** Plástico

**COLOR:** Café

MODELO	MEDIDAS – mm			PRESENTACIÓN
	“A”	“L”	“H”	
AMT-4305-05	15	50	10	Paquete de 2 pzs

## Bote salvavidas



**MATERIAL:** Plástico

**COLOR:** Café

MODELO	MEDIDAS – mm			PRESENTACIÓN
	“A”	“L”	“H”	
AMT-4305-07	20	70	15	Paquete de 2 pzs

## Bote salvavidas



**MATERIAL:** Plástico

**COLOR:** Café

MODELO	MEDIDAS – mm			PRESENTACIÓN
	“A”	“L”	“H”	
AMT-4305-08	25	85	17	Paquete de 2 pzs

## Bote salvavidas



**MATERIAL:** Plástico

**COLOR:** Café

MODELO	MEDIDAS – mm			PRESENTACIÓN
	“A”	“L”	“H”	
AMT-4305-10	30	100	20	Paquete de 2 pzs

## Remo



**MATERIAL:** Madera de balsa

**COLOR:** Natural

MODELO	MEDIDAS – mm		PRESENTACIÓN
	“A”	“L”	
AMT-4306	2	70	Paquete de 10 pzs



## Remo



**MATERIAL:** Madera de balsa

**COLOR:** Natural

MODELO	MEDIDAS – mm		PRESENTACIÓN
	“A”	“L”	
AMT-4307	2	35	Paquete de 10 pzs

## Remo



**MATERIAL:** Madera de balsa

**COLOR:** Natural

MODELO	MEDIDAS – mm		PRESENTACIÓN
	“A”	“L”	
AMT-4307-08	2	80	Paquete de 10 pzs

## Remo



**MATERIAL:** Madera de balsa

**COLOR:** Natural

MODELO	MEDIDAS – mm		PRESENTACIÓN
	“A”	“L”	
AMT-4307-10	2	100	Paquete de 10 pzs

## Remo



**MATERIAL:** Madera de balsa

**COLOR:** Natural

MODELO	MEDIDAS – mm		PRESENTACIÓN
	“A”	“L”	
AMT-4307-11	2	105	Paquete de 10 pzs

## Horquilla



**MATERIAL:** Metal

**COLOR:** Negro

**APLICACIÓN:** Pieza en forma de V sobre la cual se apoya el remo en ciertas embarcaciones, permitiéndole girar y hacer mover a la embarcación

MODELO	MEDIDAS – mm			PRESENTACIÓN
	“L”	“H”	“H1”	
AMT-4308	4	4.5	3	Paquete de 10 pzs

## Escalera



**MATERIAL:** Madera de balsa

**COLOR:** Natural

**APLICACIÓN:** Los peldaños tendrán la anchura que usted les asigne

MODELO	MEDIDAS - mm		PRESENTACIÓN
	"L"	"H"	
AMT-4320	3	90	Paquete de 2 pzs

## Escalera



**MATERIAL:** Madera de balsa

**COLOR:** Natural

**APLICACIÓN:** Los peldaños tendrán la anchura que usted les asigne

MODELO	MEDIDAS – mm		PRESENTACIÓN
	“L”	“H”	
AMT-4320-01	2	70	Paquete de 2 pzs

## Escalera



**MATERIAL:** Madera de balsa

**COLOR:** Natural

**APLICACIÓN:** Los peldaños tendrán la anchura que usted les asigne

MODELO	MEDIDAS – mm		PRESENTACIÓN
	“L”	“H”	
AMT-4320-05	5	50	Paquete de 2 pzs



## Escalera

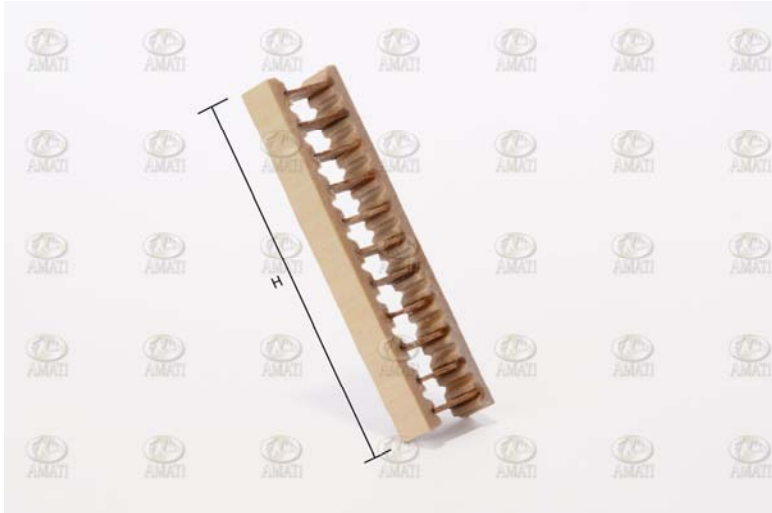

**MATERIAL:** Madera de balsa

**COLOR:** Natural

MODELO	MEDIDAS – mm		PRESENTACIÓN
	“L”	“H”	
AMT-4320-08	8	60	Paquete de 2 pzs

## Escalera



**MATERIAL:** Madera de balsa

**COLOR:** Natural

MODELO	MEDIDAS – mm		PRESENTACIÓN
	“L”	“H”	
AMT-4320-12	12	70	Paquete de 2 pzs

## Escalera

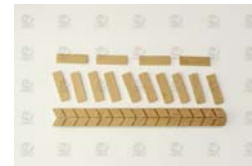

**MATERIAL:** Madera de balsa

**COLOR:** Natural

MODELO	MEDIDAS – mm		PRESENTACIÓN
	“L”	“H”	
AMT-4320-15	15	85	Paquete de 2 pzs

## Escalera



MATERIAL: Plástico

COLOR: Café

MODELO	MEDIDAS – mm			PRESENTACIÓN
	“A”	“L”	“H”	
AMT-4321	3	8	60	Paquete de 2 pzs

## Escaleras



**MATERIAL:** Metal

**COLOR:** Natural

**ACABADO:** Envejecido

MODELO	MEDIDAS – mm		PRESENTACIÓN
	“L”	“H”	
AMT-4324-01+02	18	26	Paquete de 1 par

## Escalera

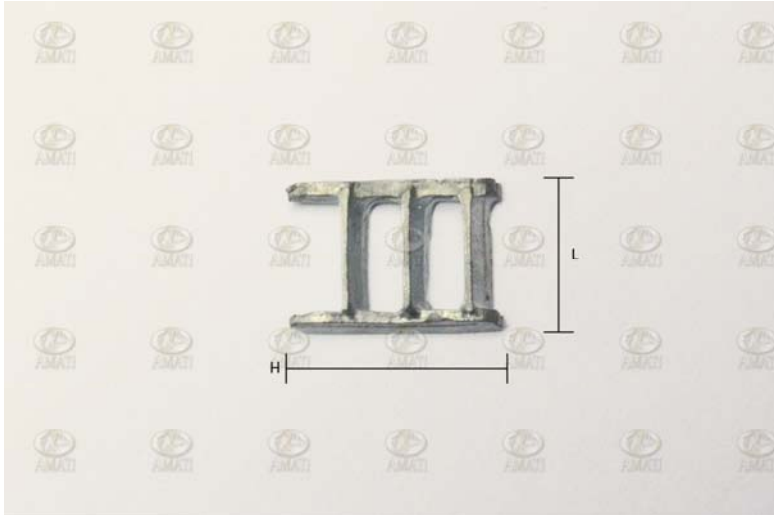

**MATERIAL:** Metal

**COLOR:** Natural

MODELO	MEDIDAS – mm		PRESENTACIÓN
	“L”	“H”	
AMT-4324-03	8	10	Paquete de 2 pzs

## Escalera

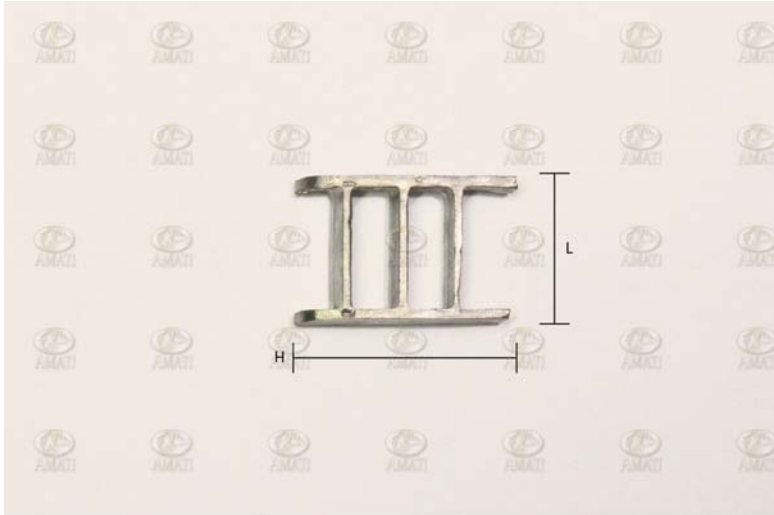

MATERIAL: Metal

COLOR: Natural

MODELO	MEDIDAS – mm		PRESENTACIÓN
	“L”	“H”	
AMT-4324-04	10	15	Paquete de 2 pzs

## Escalera



**MATERIAL:** Metal

**COLOR:** Natural

MODELO	MEDIDAS – mm		PRESENTACIÓN
	“L”	“H”	
AMT-4324-05	10	22	Paquete de 2 pzs



## Rejilla



**MATERIAL:** Madera de balsa

**COLOR:** Natural

MODELO	MEDIDAS - mm		PRESENTACIÓN
	"L"	"H"	
AMT-4325-06	30	3	Paquete de 2 pzs

## Rejilla



**MATERIAL:** Madera de balsa

**COLOR:** Natural

MODELO	MEDIDAS - mm		PRESENTACIÓN
	"L"	"H"	
AMT-4325-07	52	3	Paquete de 2 pzs

## Rejilla



MATERIAL: Plástico

COLOR: Café

MODELO	MEDIDAS – mm		PRESENTACIÓN
	“L”	“H”	
AMT-4328	38	100	Paquete de 2 pzs

## Fanal de popa



**MATERIAL:** Latón

**COLOR:** Natural

**APLICACIÓN:** Se le conoce también como faro, farol o linterna

MODELO	MEDIDAS – mm				PRESENTACIÓN
	“L”	“H”	“H1”	“d”	
AMT-4330-01	12	43	22	2	Paquete de 2 pzs
AMT-4330-02	16	45	30	2	Paquete de 2 pzs

## Fanal de popa



**MATERIAL:** Latón

**COLOR:** Natural

**APLICACIÓN:** Se le conoce también como faro, farol o linterna

MODELO	MEDIDAS – mm				PRESENTACIÓN
	“L”	“H”	“H1”	“d”	
AMT-4330-03	16	73	30	2	Paquete de 2 pzs

## Fanal de popa



**MATERIAL:** Latón

**COLOR:** Natural

**ACABADO:** Envejecido

**APLICACIÓN:** Se le conoce también como faro, farol o linterna

MODELO	MEDIDAS – mm				PRESENTACIÓN
	“L”	“H”	“H1”	“d”	
AMT-4330-04	16	50	25	2	Paquete de 2 pzs

## Fanal de popa



**MATERIAL:** Latón

**COLOR:** Natural

**ACABADO:** Envejecido

**APLICACIÓN:** Se le conoce también como faro, farol o linterna

MODELO	MEDIDAS – mm				PRESENTACIÓN
	“H”	“H1”	“d”	“d1”	
AMT-4330-07	55	25	13	2	Paquete de 2 pzs

## Fanal de popa



**MATERIAL:** Latón

**COLOR:** Natural

**APLICACIÓN:** Se le conoce también como faro, farol o linterna

MODELO	MEDIDAS – mm			PRESENTACIÓN
	“L”	“H”	“H1”	
AMT-4338-01	30	42	22	Paquete de 2 pzs
AMT-4338-02	33	50	30	Paquete de 2 pzs



## Fanal de popa



**MATERIAL:** Latón

**COLOR:** Natural

**APLICACIÓN:** Se le conoce también como faro, farol o linterna

MODELO	MEDIDAS – mm			PRESENTACIÓN
	“L”	“H”	“H1”	
AMT-4338-03	30	50	30	Paquete de 2 pzs

## Fanal de popa



**MATERIAL:** Latón

**COLOR:** Natural

**APLICACIÓN:** Se le conoce también como faro, farol o linterna

MODELO	MEDIDAS – mm			PRESENTACIÓN
	“L”	“H”	“H1”	
AMT-4338-04	30	50	25	Paquete de 2 pzs

## Fanal de gavia

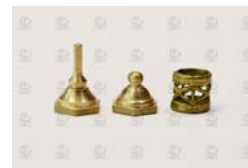
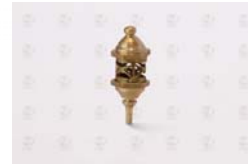

**MATERIAL:** Latón

**COLOR:** Natural

**ACABADO:** Envejecido

**APLICACIÓN:** Se le conoce también como faro, farol o linterna

MODELO	MEDIDAS – mm		PRESENTACIÓN
	“H”	“H1”	
AMT-4345	20	14	Paquete de 2 pzs

## Piloto de viento

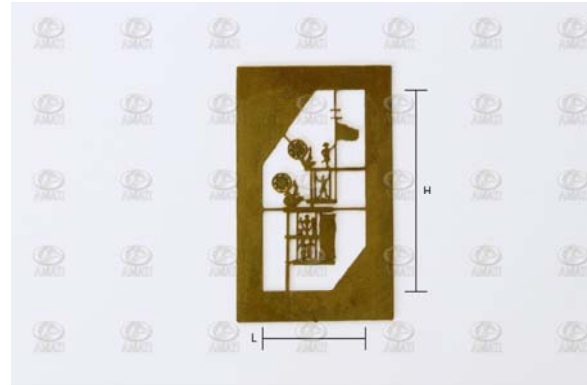

**MATERIAL:** Latón

**COLOR:** Natural

**APLICACIÓN:** Aparato que ayuda a indicar la dirección del viento al ir navegando

MODELO	MEDIDAS – mm		PRESENTACIÓN
	“L”	“H”	
AMT-4346	8	22	Pieza

## Timón

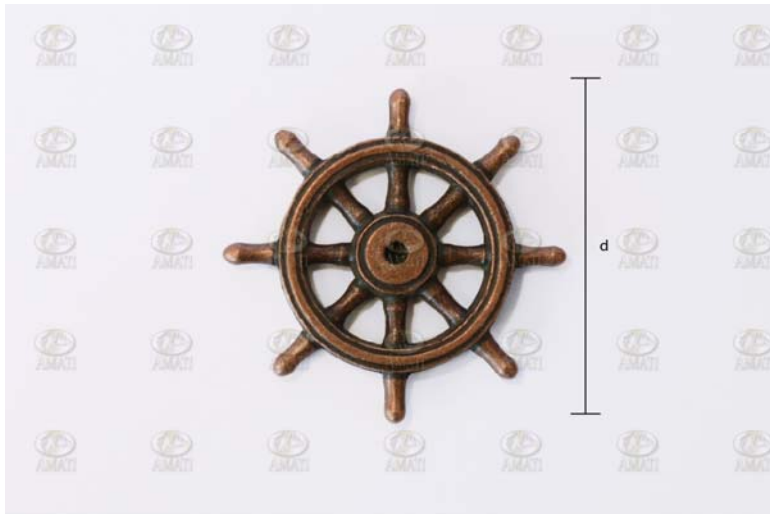

MATERIAL:	Metal
COLOR:	Natural
ACABADO:	Envejecido
APLICACIÓN:	Permite a quien pilotea, controlar el timón de la nave

MODELO	MEDIDAS – mm		PRESENTACIÓN
	“A”	“d”	
AMT-4350-14	2	14	Paquete de 2 pzs
AMT-4350-20	2	20	Paquete de 2 pzs
AMT-4350-30	3	30	Paquete de 2 pzs
AMT-4350-38	5	38	Paquete de 2 pzs

## Timón con base



**MATERIAL:** Metal

**COLOR:** Natural

**ACABADO:** Envejecido

**APLICACIÓN:** Permite a quien pilotea, controlar el timón de la nave

MODELO	MEDIDAS – mm				PRESENTACIÓN
	“A”	“H”	“H1”	“d”	
AMT-4350-15	5	11	15	14	Paquete de 2 pzs
AMT-4350-31	20	30	25	30	Paquete de 2 pzs

## Timón con base



**MATERIAL:** Metal

**COLOR:** Natural

**APLICACIÓN:** Permite a quien pilotea, controlar el timón de la nave

MODELO	MEDIDAS – mm				PRESENTACIÓN
	“A”	“H”	“H1”	“d”	
AMT-4350-50	8	30	20	50	Paquete de 2 pzs

## Soporte para timón



MATERIAL: Metal

COLOR: Natural

ACABADO: Envejecido

MODELO	MEDIDAS – mm			PRESENTACIÓN
	“A”	“L”	“H”	
AMT-4351	14	20	50	Paquete de 2 pzs



## Barra de timón



- MATERIAL:** Metal
- COLOR:** Natural
- ACABADO:** Envejecido
- APLICACIÓN:** Palanca que ajustada a la cabeza del timón, sirve para hacerlo girar

MODELO	MEDIDAS – mm		PRESENTACIÓN
	“A”	“L”	
AMT-4352-40	6	40	Paquete de 2 pzs

## Timón



**MATERIAL:** Madera de boj

**COLOR:** Natural

MODELO	MEDIDAS – mm		PRESENTACIÓN
	“A”	“d”	
AMT-4353-20	5	20	Paquete de 2 pzs
AMT-4353-30	5	30	Paquete de 2 pzs
AMT-4353-40	5	40	Paquete de 2 pzs

## Bomba simple



<b>MATERIAL:</b>	Metal		
<b>COLOR:</b>	Natural		
<b>ACABADO:</b>	Envejecido		
<b>APLICACIÓN:</b>	Sirven para la extracción o evacuación del agua que entrega en la embarcación		
MODELO	MEDIDAS – mm		PRESENTACIÓN
	“L”	“H”	
AMT-4355-01	15	7	Paquete de 2 pzs

## Bomba simple

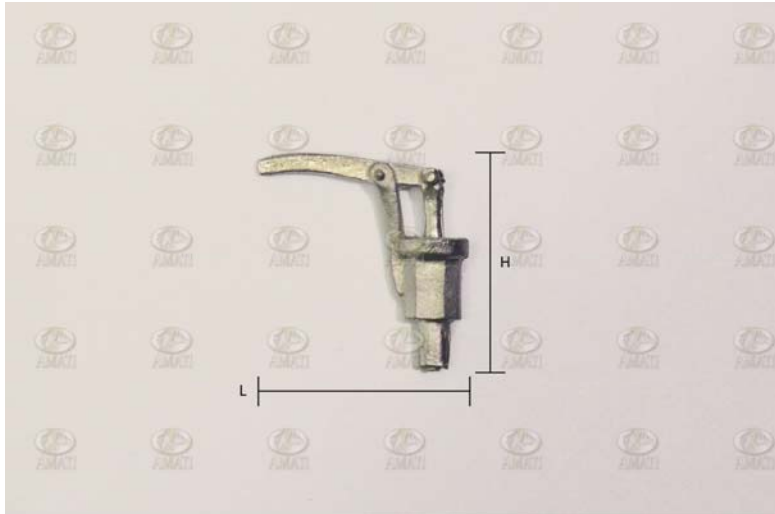

**MATERIAL:** Metal

**COLOR:** Natural

**APLICACIÓN:** Sirve para la extracción el agua que entrega en la embarcación

MODELO	MEDIDAS – mm			PRESENTACIÓN
	“L”	“H”	“d”	
AMT-4355-02	15	13	12	Paquete de 2 pzs

## Bomba simple



**MATERIAL:** Metal

**COLOR:** Natural

**ACABADO:** Envejecido

**APLICACIÓN:** Sirven para la extracción o evacuación del agua que entrega en la embarcación

MODELO	MEDIDAS – mm		PRESENTACIÓN
	“L”	“H”	
AMT-4355-03	10	18	Paquete de 2 pzs

## Bomba simple

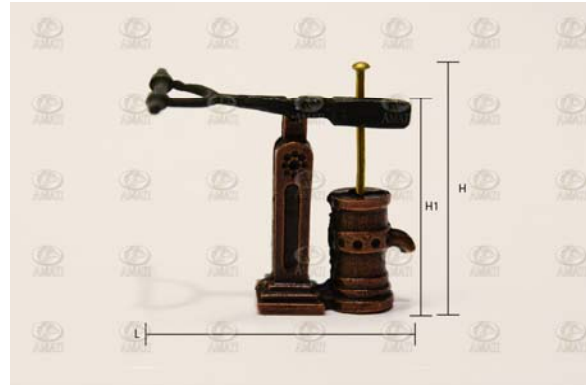

**MATERIAL:** Metal

**COLOR:** Natural

**ACABADO:** Envejecido

**APLICACIÓN:** Sirven para la extracción o evacuación del agua que entrega en la embarcación

MODELO	MEDIDAS – mm			PRESENTACIÓN
	“L”	“H”	“d”	
AMT-4355-04	16	16	12	Paquete de 2 pzs
AMT-4355-05	22	22	18	Paquete de 2 pzs

## Bomba doble



**MATERIAL:** Metal

**COLOR:** Natural

**ACABADO:** Envejecido

**APLICACIÓN:** Sirven para la extracción o evacuación del agua que entrega en la embarcación

MODELO	MEDIDAS – mm			PRESENTACIÓN
	“L”	“L1”	“H”	
AMT-4355-08	24	15	11	Paquete de 2 pzs

## Bomba doble



**MATERIAL:** Metal

**COLOR:** Natural

**ACABADO:** Envejecido

**APLICACIÓN:** Sirven para la extracción o evacuación del agua que entrega en la embarcación

MODELO	MEDIDAS – mm			PRESENTACIÓN
	“L”	“L1”	“H”	
AMT-4355-09	39	20	18	Paquete de 2 pzs



## Bomba simple

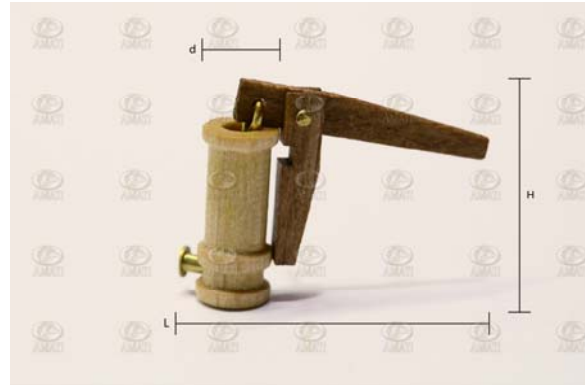

**MATERIAL:** Madera de balsa

**COLOR:** Natural

**APLICACIÓN:** Sirven para la extracción o evacuación del agua que entrega en la embarcación

MODELO	MEDIDAS – mm			PRESENTACIÓN
	“L”	“H”	“d”	
AMT-4356	22	15	6	Paquete de 2 pzs

## Cadena



**MATERIAL:** Latón

**COLOR:** Bronce

MODELO	MEDIDAS – mm	PRESENTACIÓN
	“A”	
AMT-4360-02	1	Pieza

## Cadena



MATERIAL: Latón

COLOR: Bronce

MODELO	MEDIDAS – mm	PRESENTACIÓN
	“A”	
AMT-4360-03	2.5	Pieza

## Cadena



MATERIAL: Latón

COLOR: Bronce

MODELO	MEDIDAS – mm	PRESENTACIÓN
	“A”	
AMT-4360-04	3.5	Pieza

## Cadena



MATERIAL: Latón

COLOR: Dorado

MODELO	MEDIDAS – mm	PRESENTACIÓN
	“A”	
AMT-4360-05	5	Pieza

## Cadena



MATERIAL: Latón

COLOR: Dorado

MODELO	MEDIDAS – mm	PRESENTACIÓN
	“A”	
AMT-4360-06	5	Pieza

## Cadena



MATERIAL: Latón

COLOR: Dorado

MODELO	MEDIDAS – mm	PRESENTACIÓN
	“A”	
AMT-4360-07	3.5	Pieza

## Cadena



**MATERIAL:** Latón

**COLOR:** Dorado

MODELO	MEDIDAS – mm		PRESENTACIÓN
	“A”	“d”	
AMT-4360-10	3	3	Pieza



## Bisagras con perno

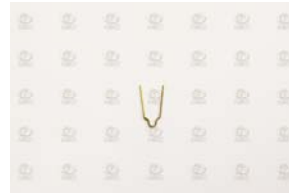

MATERIAL: Latón

COLOR: Natural

MODELO	MEDIDAS – mm		PRESENTACIÓN
	“L”	“H”	
AMT-4370-05	24	8	Paquete de 5 pzs
AMT-4370-06	32	10	Paquete de 5 pzs

## Bisagras con perno

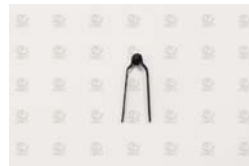

MATERIAL: Latón

COLOR: Negro

MODELO	MEDIDAS – mm		PRESENTACIÓN
	“L”	“H”	
AMT-4371-03	26	6	Paquete de 5 pzs
AMT-4371-05	30	10	Paquete de 5 pzs

## Bola con orificio



**MATERIAL:** Madera de balsa

**COLOR:** Natural

**APLICACIÓN:** Bola de madera que forma parte del emparrillado de mástil. También conocida como "galleta"

MODELO	MEDIDAS – mm		PRESENTACIÓN
	“d”	“d1”	
AMT-4380-02	2	1	Paquete de 20 pzs

## Bola lisa



**MATERIAL:** Madera de balsa

**COLOR:** Natural

**APLICACIÓN:** Bola de madera que forma parte del emparrillado de mástil. También conocida como “galleta”

MODELO	MEDIDAS – mm	PRESENTACIÓN
	“d”	
AMT-4380-03	3	Paquete de 20 pzs

## Bola con orificio



**MATERIAL:** Madera de balsa

**COLOR:** Natural

**APLICACIÓN:** Bola de madera que forma parte del emparrillado de mástil. También conocida como "galleta"

MODELO	MEDIDAS – mm		PRESENTACIÓN
	“d”	“d1”	
AMT-4380-04	4	2	Paquete de 20 pzs

## Bola lisa



**MATERIAL:** Madera de balsa

**COLOR:** Natural

**APLICACIÓN:** Bola de madera que forma parte del emparrillado de mástil. También conocida como “galleta”

MODELO	MEDIDAS – mm	PRESENTACIÓN
	“d”	
AMT-4380-05	5	Paquete de 20 pzs

## Bola con orificio



**MATERIAL:** Madera de balsa

**COLOR:** Natural

**APLICACIÓN:** Bola de madera que forma parte del emparrillado de mástil. También conocida como “galleta”

MODELO	MEDIDAS – mm		PRESENTACIÓN
	“d”	“d1”	
AMT-4380-06	6	2	Paquete de 20 pzs

## Bola lisa



**MATERIAL:** Madera de balsa

**COLOR:** Natural

**APLICACIÓN:** Bola de madera que forma parte del emparrillado de mástil. También conocida como “galleta”

MODELO	MEDIDAS – mm	PRESENTACIÓN
	“d”	
AMT-4380-08	8	Paquete de 20 pzs



## Bola lisa



**MATERIAL:** Madera de balsa

**COLOR:** Natural

**APLICACIÓN:** Bola de madera que forma parte del emparrillado de mástil. También conocida como "galleta"

MODELO	MEDIDAS – mm	PRESENTACIÓN
	“d”	
AMT-4380-10	10	Paquete de 20 pzs

## Bola lisa



**MATERIAL:** Madera de balsa

**COLOR:** Natural

**APLICACIÓN:** Bola de madera que forma parte del emparrillado de mástil. También conocida como "galleta"

MODELO	MEDIDAS – mm	PRESENTACIÓN
	“d”	
AMT-4380-12	12	Paquete de 20 pzs

## Bola lisa



**MATERIAL:** Madera de balsa

**COLOR:** Natural

**APLICACIÓN:** Bola de madera que forma parte del emparrillado de mástil. También conocida como "galleta"

MODELO	MEDIDAS – mm	PRESENTACIÓN
	“d”	
AMT-4380-15	15	Paquete de 20 pzs

## Bola lisa



**MATERIAL:** Madera de balsa

**COLOR:** Natural

**APLICACIÓN:** Bola de madera que forma parte del emparrillado de mástil. También conocida como “galleta”

MODELO	MEDIDAS – mm	PRESENTACIÓN
	“d”	
AMT-4380-20	20	Paquete de 20 pzs

## Bola con orificio



**MATERIAL:** Latón

**COLOR:** Natural

**APLICACIÓN:** Bola de madera que forma parte del emparrillado de mástil. También conocida como "galleta"

MODELO	MEDIDAS – mm		PRESENTACIÓN
	“d”	“d1”	
AMT-4382-02	2	0.5	Paquete de 20 pzs

## Bola con orificio



**MATERIAL:** Latón

**COLOR:** Natural

**APLICACIÓN:** Bola de madera que forma parte del emparrillado de mástil. También conocida como “galleta”

MODELO	MEDIDAS – mm		PRESENTACIÓN
	“d”	“d1”	
AMT-4382-03	3.5	1	Paquete de 20 pzs

## Articulación de verga



MATERIAL:	Metal
COLOR:	Natural
ACABADO:	Envejecido
APLICACIÓN:	Eje que permite el movimiento de ascenso o descenso, de la verga que sostiene a la vela

MODELO	MEDIDAS – mm		PRESENTACIÓN
	“L”	“H”	
AMT-4383-06	20	10	Paquete de 2 pzs

## Emparrillado de mástil

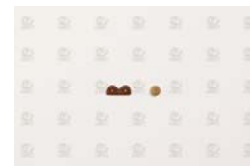
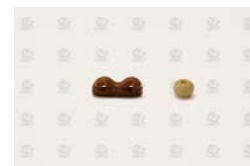

**MATERIAL:** Madera de balsa

**COLOR:** Natural

**APLICACIÓN:** Conjunto de piezas de madera (vertellos) cruzadas en ángulos rectos, que forma la base o cimiento para articular la verga y el mástil

MODELO	MEDIDAS – mm	PRESENTACIÓN
	“A”	
AMT-4384-06	6	Paquete de 2 pzas



## Emparrillado de mástil

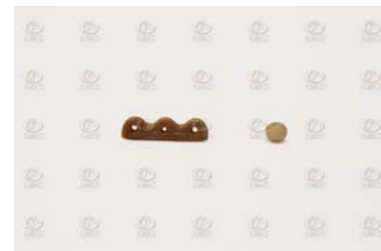
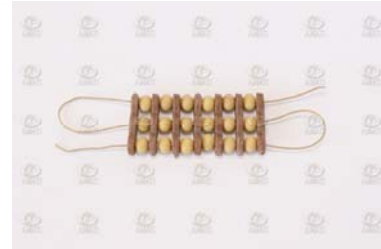
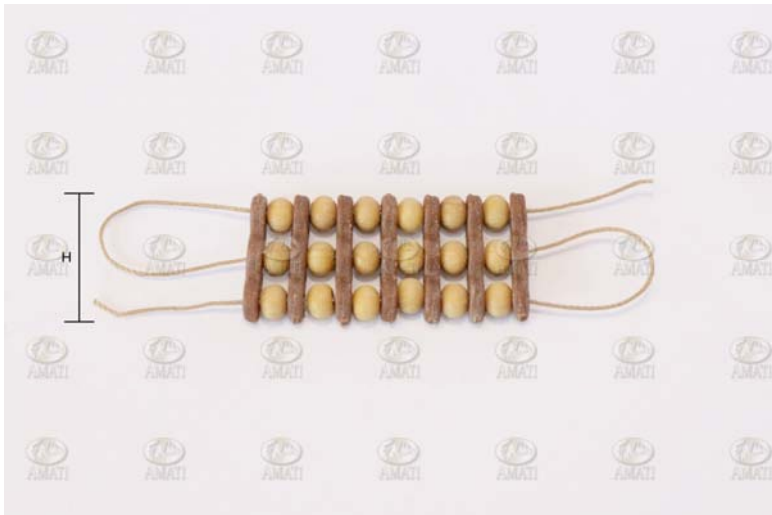

**MATERIAL:** Madera de balsa

**COLOR:** Natural

**APLICACIÓN:** Conjunto de piezas de madera (vertellos) cruzadas en ángulos rectos, que forma la base o cimiento para articular la verga y el mástil

MODELO	MEDIDAS – mm	PRESENTACIÓN
	“A”	
AMT-4384-10	10	Paquete de 2 pzs

## Celosía orificio redondo



**MATERIAL:** Latón

**COLOR:** Natural

**APLICACIÓN:** Es el enrejado de listoncillos de madera o hierro, que se pone en las ventanas de los barcos, para que las personas del interior vean sin ser vistas

MODELO	MEDIDAS – mm		PRESENTACIÓN
	“L”	“H”	
AMT-4390-01	150	24	Paquete de 2 pzs

## Celosía orificio rombo



**MATERIAL:** Latón

**COLOR:** Natural

**APLICACIÓN:** Es el enrejado de listoncillos de madera o hierro, que se pone en las ventanas de los barcos, para que las personas del interior vean sin ser vistas

MODELO	MEDIDAS – mm		PRESENTACIÓN
	“L”	“H”	
AMT-4390-02	150	30	Paquete de 2 pzs

## Tejas

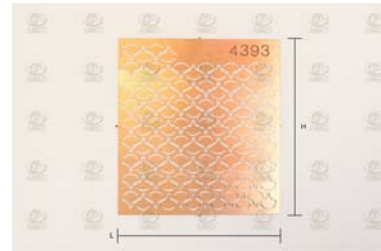

**MATERIAL:** Metal

**COLOR:** Bronce

MODELO	MEDIDAS – mm			PRESENTACIÓN
	“L”	“L1”	“H”	
AMT-4393	7	5	14	Paquete de 100 pzs

## Manija



**MATERIAL:** Metal

**COLOR:** Bronce

**APLICACIÓN:** Para poder abrir puertas, compuertas y cofres

MODELO	MEDIDAS – mm				PRESENTACIÓN
	“A”	“L”	“H”	“d”	
AMT-4394	2	10	5	1	Paquete de 10 pzs

## Pie de mástil



<b>MATERIAL:</b>	Metal
<b>COLOR:</b>	Natural
<b>ACABADO:</b>	Envejecido
<b>APLICACIÓN:</b>	Orificio que se ubica en la cubierta, donde se colocan los mástiles

MODELO	MEDIDAS – mm		PRESENTACIÓN
	“d”	“d1”	
AMT-4395-06	12	6	Paquete de 2 pzs

## Pie de mástil



**MATERIAL:** Metal

**COLOR:** Natural

**ACABADO:** Envejecido

**APLICACIÓN:** Orificio que se ubica en la cubierta, donde se colocan los mástiles

MODELO	MEDIDAS – mm		PRESENTACIÓN
	“d”	“d1”	
AMT-4395-08	16	8	Paquete de 2 pzs

## Pie de mástil



<b>MATERIAL:</b>	Metal
<b>COLOR:</b>	Gris
<b>APLICACIÓN:</b>	Orificio que se ubica en la cubierta, donde se colocan los mástiles

MODELO	MEDIDAS – mm		PRESENTACIÓN
	“d”	“d1”	
AMT-4395-10	18	10	Paquete de 2 pzs



## Pie de mástil



<b>MATERIAL:</b>	Metal
<b>COLOR:</b>	Natural
<b>ACABADO:</b>	Envejecido
<b>APLICACIÓN:</b>	Orificio que se ubica en la cubierta, donde se colocan los mástiles

MODELO	MEDIDAS – mm		PRESENTACIÓN
	“d”	“d1”	
AMT-4395-12	20	12	Paquete de 2 pzs

## Luces de posición



<b>MATERIAL:</b>	Metal
<b>COLOR:</b>	Natural
<b>ACABADO:</b>	Envejecido
<b>APLICACIÓN:</b>	Diseñadas para que los demás barcos observen en qué posición se le está viendo a otro barco; si se le ve por proa, popa, babor o estribor

MODELO	MEDIDAS – mm		PRESENTACIÓN
	“A”	“L”	
AMT-4695	7	20	Paquete de 2 pzs
AMT-4696	8	21	Paquete de 2 pzs

## Luz de navegación

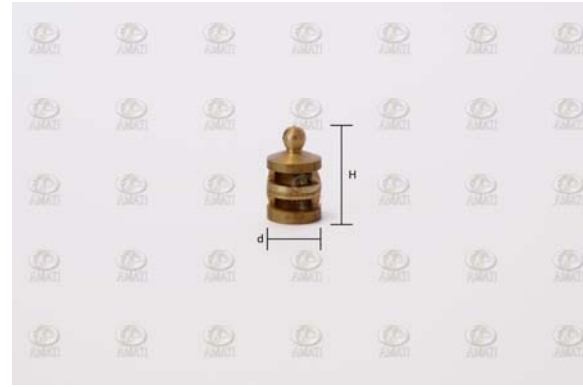

**MATERIAL:** Latón

**COLOR:** Natural

**APLICACIÓN:** Se instalan a bordo de cualquier embarcación, con el fin de alertar a las otras naves en el área, de su presencia

MODELO	MEDIDAS – mm		PRESENTACIÓN
	“H”	“d”	
AMT-4700-01	6	3	Paquete de 4 pzs

## Luz de navegación



**MATERIAL:** Latón

**COLOR:** Natural

**APLICACIÓN:** Se instalan a bordo de cualquier embarcación, con el fin de alertar a las otras naves en el área, de su presencia

MODELO	MEDIDAS – mm		PRESENTACIÓN
	“H”	“d”	
AMT-4700-02	8	4.5	Paquete de 4 pzs

## Luz de navegación



<b>MATERIAL:</b>	Latón
<b>COLOR:</b>	Natural
<b>APLICACIÓN:</b>	Se instalan a bordo de cualquier embarcación, con el fin de alertar a las otras naves en el área, de su presencia

MODELO	MEDIDAS – mm		PRESENTACIÓN
	“H”	“d”	
AMT-4700-04	12	8	Paquete de 2 pzs

## Chaveta

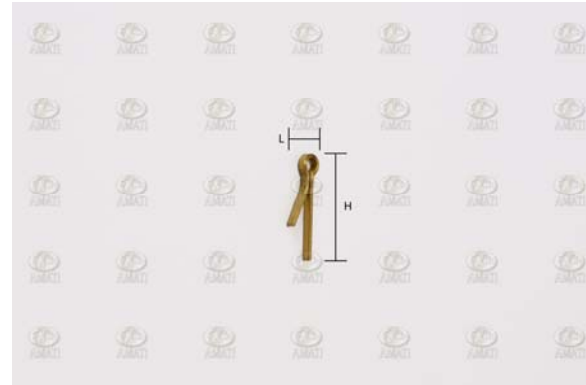

**MATERIAL:** Latón

**COLOR:** Natural

**APLICACIÓN:** Sirve para enganchar motones y amarrar cabos

MODELO	MEDIDAS – mm		PRESENTACIÓN
	“L”	“H”	
AMT-4702	0.7	10	Paquete de 100 pzs

## Chaveta

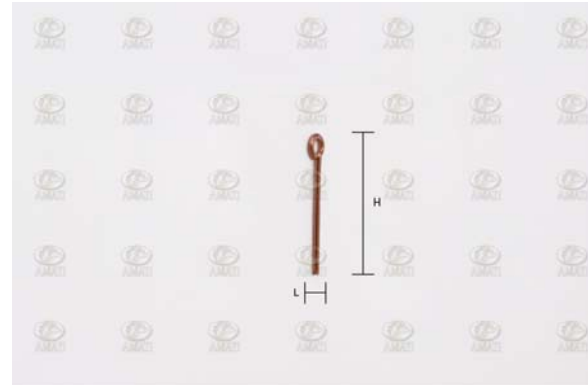

**MATERIAL:** Latón

**COLOR:** Natural

**APLICACIÓN:** Sirve para enganchar motones y amarrar cabos

MODELO	MEDIDAS – mm		PRESENTACIÓN
	“L”	“H”	
AMT-4703	0.5	11	Paquete de 100 pzs

## Chaveta



**MATERIAL:** Latón

**COLOR:** Natural

**APLICACIÓN:** Sirve para enganchar motones y amarrar cabos

MODELO	MEDIDAS – mm		PRESENTACIÓN
	“L”	“H”	
AMT-4704	0.7	10	Paquete de 100 pzs



## Cáncamo

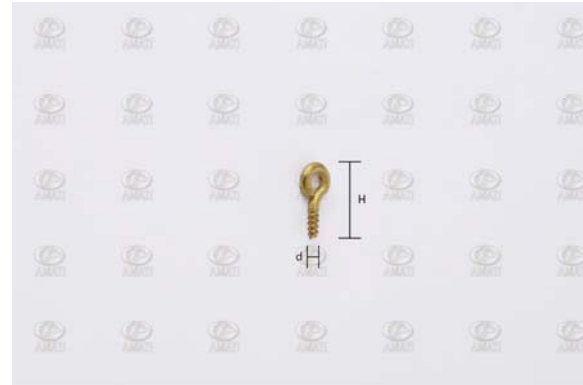

**MATERIAL:** Latón

**COLOR:** Natural

**APLICACIÓN:** Sirve para enganchar motones y amarrar cabos

MODELO	MEDIDAS – mm		PRESENTACIÓN
	“L”	“H”	
AMT-4705	4	8	Paquete de 20 pzs
AMT-4705-01	5	9	Paquete de 20 pzs
AMT-4705-02	6	12	Paquete de 20 pzs

## Garfio simple



**MATERIAL:**

Metal

**COLOR:**

Natural

**APLICACIÓN:**

Sirve a los proeles (marinero) para acercar o alejar de cualquier paraje, y hacer empuje y contener la velocidad que llevan en una mala atracada

MODELO	MEDIDAS – mm	PRESENTACIÓN
	“d”	
AMT-4750-01	57	Paquete de 5 pzs

## Garfio doble



**MATERIAL:** Metal

**COLOR:** Natural

**APLICACIÓN:** Sirve a los proeles (marinero) para acercar o alejar de cualquier paraje, y hacer empuje y contener la velocidad que llevan en una mala atracada

MODELO	MEDIDAS – mm	PRESENTACIÓN
	“d”	
AMT-4750-02	57	Paquete de 5 pzs

## Pescante con base



<b>MATERIAL:</b>	Metal
<b>COLOR:</b>	Natural
<b>ACABADO:</b>	Envejecido
<b>APLICACIÓN:</b>	Pieza saliente de madera o hierro sujeta al costado de un navío, que sirve para sostener o colgar algo de ella

MODELO	MEDIDAS – mm		PRESENTACIÓN
	“L”	“H”	
AMT-4800-20	20	20	Paquete de 2 pzs

## Pescante con base



**MATERIAL:** Metal

**COLOR:** Negro

**APLICACIÓN:** Pieza saliente de madera o hierro sujeta al costado de un navío, que sirve para sostener o colgar algo de ella

MODELO	MEDIDAS – mm	PRESENTACIÓN
	“H”	
AMT-4800-45	45	Paquete de 2 pzs

## Pescante con base



**MATERIAL:** Metal

**COLOR:** Negro

**APLICACIÓN:** Pieza saliente de madera o hierro sujeta al costado de un navío, que sirve para sostener o colgar algo de ella

MODELO	MEDIDAS – mm	PRESENTACIÓN
	“H”	
AMT-4800-55	55	Paquete de 2 pzs

## Pescante con base



**MATERIAL:** Metal

**COLOR:** Negro

**APLICACIÓN:** Pieza saliente de madera o hierro sujeta al costado de un navío, que sirve para sostener o colgar algo de ella

MODELO	MEDIDAS – mm	PRESENTACIÓN
	“H”	
AMT-4802	45	Paquete de 2 pzs

## Pescante con base



**MATERIAL:** Metal

**COLOR:** Natural

**ACABADO:** Envejecido

**APLICACIÓN:** Pieza saliente de madera o hierro sujeta al costado de un navío, que sirve para sostener o colgar algo de ella

MODELO	MEDIDAS – mm	PRESENTACIÓN
	“H”	
AMT-4804	65	Pieza



## Sirena



**MATERIAL:** Metal

**COLOR:** Natural

MODELO	MEDIDAS – mm		PRESENTACIÓN
	“L”	“H”	
AMT-4805	20	19	Pieza

## Timón



MATERIAL: Metal

COLOR: Natural

MODELO	MEDIDAS – mm	PRESENTACIÓN
	“d”	
AMT-4806	40	Pieza

## Bitácora



<b>MATERIAL:</b>	Metal
<b>COLOR:</b>	Natural
<b>ACABADO:</b>	Envejecido
<b>APLICACIÓN:</b>	Caja a modo de armario, fija a la cubierta e inmediata al timón, en la cual va montada la aguja náutica o compás

MODELO	MEDIDAS – mm		PRESENTACIÓN
	“L”	“H”	
AMT-4813	18	22	Paquete de 2 pzs

## Telégrafo



**MATERIAL:** Metal

**COLOR:** Natural

**ACABADO:** Envejecido

MODELO	MEDIDAS – mm		PRESENTACIÓN
	“L”	“H”	
AMT-4814	10	17	Paquete de 2 pzs

## Ventilador



**MATERIAL:** Metal

**COLOR:** Natural

**ACABADO:** Envejecido

MODELO	MEDIDAS – mm		PRESENTACIÓN
	“H”	“d”	
AMT-4815-12	12	2	Paquete de 4 pzs
AMT-4815-20	20	4	Paquete de 4 pzs
AMT-4815-32	32	5	Paquete de 4 pzs
AMT-4815-45	45	6	Paquete de 4 pzs

## Ventilador



**MATERIAL:** Metal

**COLOR:** Natural

**ACABADO:** Envejecido

MODELO	MEDIDAS – mm		PRESENTACIÓN
	“H”	“d”	
AMT-4816-50	50	12	Paquete de 2 pzs
AMT-4816-60	60	15	Paquete de 2 pzs

## Respiradero



**MATERIAL:** Metal

**COLOR:** Natural

**ACABADO:** Envejecido

MODELO	MEDIDAS – mm		PRESENTACIÓN
	“H”	“d”	
AMT-4818	22	16	Paquete de 2 pzs

## Respiradero



MATERIAL: Metal

COLOR: Natural

ACABADO: Envejecido

MODELO	MEDIDAS – mm		PRESENTACIÓN
	“H”	“d”	
AMT-4819	19	6	Paquete de 2 pzs



## Salvavidas

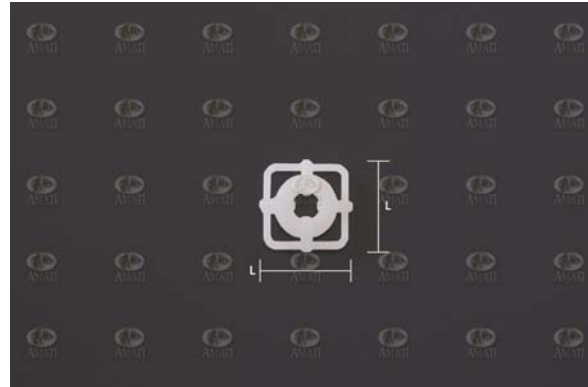
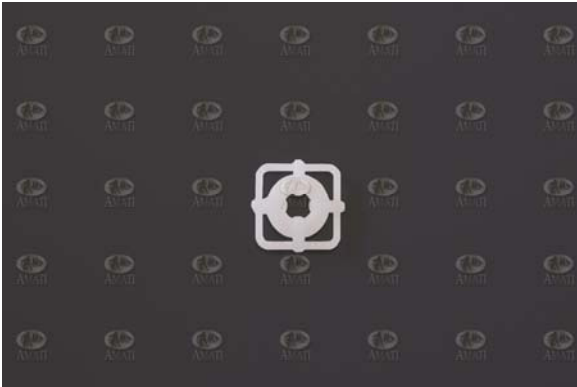

**MATERIAL:** Plástico

**COLOR:** Blanco

MODELO	MEDIDAS – mm	PRESENTACIÓN
	“L”	
AMT-4820-10	10	Paquete de 10 pzs
AMT-4820-15	15	Paquete de 10 pzs
AMT-4820-25	25	Paquete de 10 pzs

## Propela



**MATERIAL:** Metal

**COLOR:** Natural

**ACABADO:** Envejecido

**APLICACIÓN:** También conocida como hélice

MODELO	MEDIDAS – mm	PRESENTACIÓN
	“d”	
AMT-4827-30	30	Pieza
AMT-4827-40	40	Pieza
AMT-4827-50	50	Pieza

## Propela



MATERIAL:	Metal
COLOR:	Natural
ACABADO:	Envejecido
APLICACIÓN:	También conocidas como hélices

MODELO	MEDIDAS – mm	PRESENTACIÓN
	“d”	
AMT-4828-12+13	12	Paquete de 1 par
AMT-4828-20+21	20	Paquete de 1 par
AMT-4828-30+31	30	Paquete de 1 par
AMT-4828-40+41	40	Paquete de 1 par

## Eje para propela

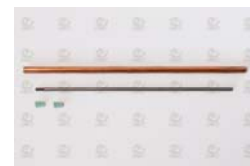

MATERIAL: Metal

COLOR: Bronce

MODELO	MEDIDAS – mm				PRESENTACIÓN
	“L”	“L1”	“d”	“d1”	
AMT-4830-12	135	120	4	2	Paquete de 2 pzs

## Soporte para propela



**MATERIAL:** Metal

**COLOR:** Natural

**APLICACIÓN:** Pieza de madera o hierro, que sobresale del casco del navío, para sostener el eje de la propela

MODELO	MEDIDAS – mm		PRESENTACIÓN
	“L”	“H”	
AMT-4831	14	15	Paquete de 2 pzs

## Polea



**MATERIAL:** Latón

**COLOR:** Natural

MODELO	MEDIDAS – mm	PRESENTACIÓN
	“d”	
AMT-4850-02	2.5	Paquete de 20 pzs
AMT-4850-04	4	Paquete de 20 pzs
AMT-4850-06	6	Paquete de 20 pzs
AMT-4850-08	8	Paquete de 20 pzs
AMT-4850-10	10	Paquete de 20 pzs

## Polea



MATERIAL: Latón

COLOR: Natural

MODELO	MEDIDAS – mm		PRESENTACIÓN
	“L”	“H”	
AMT-4851	18	13	Paquete de 2 pzs

## Carrucha



**MATERIAL:** Latón

**COLOR:** Natural

**APLICACIÓN:** También conocida como polea

MODELO	MEDIDAS – mm		PRESENTACIÓN
	“H”	“d”	
AMT-4855-02	12	6	Paquete de 5 pzs



## Carrucha



**MATERIAL:** Latón

**COLOR:** Natural

**APLICACIÓN:** También conocida como polea

MODELO	MEDIDAS – mm			PRESENTACIÓN
	“L”	“H”	“d”	
AMT-4855-03	9	8	6	Paquete de 5 pzs

## Carrucha



**MATERIAL:** Latón

**COLOR:** Natural

**APLICACIÓN:** También conocida como polea

MODELO	MEDIDAS – mm		PRESENTACIÓN
	“L”	“H”	
AMT-4855-05	13	8	Paquete de 5 pzs

## Carrucha

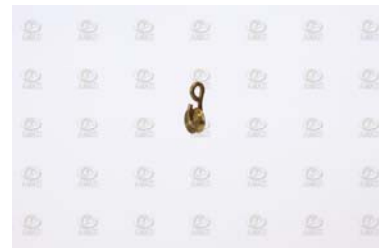

**MATERIAL:** Latón

**COLOR:** Natural

**APLICACIÓN:** También conocida como polea

MODELO	MEDIDAS – mm		PRESENTACIÓN
	“H”	“d”	
AMT-4855-06	7	4	Paquete de 5 pzs

## Bloque de polea sencilla

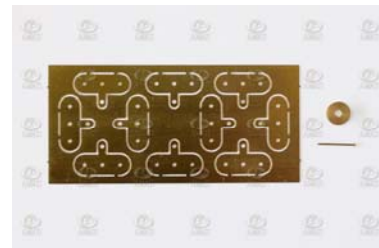

**MATERIAL:** Latón

**COLOR:** Natural

MODELO	MEDIDAS – mm			PRESENTACIÓN
	“L”	“H”	“d”	
AMT-4856-06	8	6.5	6	Paquete de 10 pzs

## Bloque de polea sencilla



MATERIAL: Latón

COLOR: Natural

MODELO	MEDIDAS – mm		PRESENTACIÓN
	“L”	“H”	
AMT-4856-07	13	5	Paquete de 10 pzs

## Bloque de polea sencilla



**MATERIAL:** Latón

**COLOR:** Natural

MODELO	MEDIDAS – mm		PRESENTACIÓN
	“H”	“d”	
AMT-4856-08	12	6	Paquete de 10 pzs

## Bloque de polea sencilla



**MATERIAL:** Latón

**COLOR:** Natural

MODELO	MEDIDAS – mm		PRESENTACIÓN
	“H”	“d”	
AMT-4856-10	7	6	Paquete de 10 pzs

## Winch



**MATERIAL:** Metal

**COLOR:** Natural

**ACABADO:** Envejecido

**APLICACIÓN:** Sirve para mover piezas de mucho peso, por ejemplo, el ancla en las maniobras de fondeo. También conocido como cabrestante

MODELO	MEDIDAS – mm				PRESENTACIÓN
	“L”	“H”	“H1”	“d”	
AMT-4859-01	10	6	4	3	Pieza



## Winch

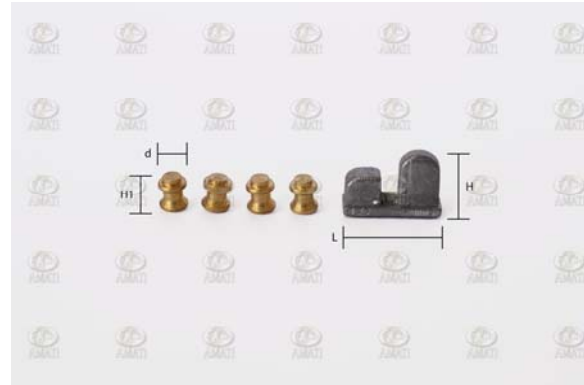

**MATERIAL:** Metal

**COLOR:** Natural

**ACABADO:** Envejecido

**APLICACIÓN:** Sirve para mover piezas de mucho peso, por ejemplo, el ancla en las maniobras de fondeo. También conocido como cabrestante

MODELO	MEDIDAS – mm				PRESENTACIÓN
	“L”	“H”	“H1”	“d”	
AMT-4859-02	10	6	4	3	Pieza

## Winch



- MATERIAL:** Metal
- COLOR:** Natural
- ACABADO:** Envejecido
- APLICACIÓN:** Sirve para mover piezas de mucho peso, por ejemplo, el ancla en las maniobras de fondeo. También conocido como cabrestante

MODELO	MEDIDAS – mm		PRESENTACIÓN
	“A”	“L”	
AMT-4860	46	35	Pieza

## Winch



**MATERIAL:** Metal

**COLOR:** Natural

**ACABADO:** Envejecido

**APLICACIÓN:** Sirve para mover piezas de mucho peso, por ejemplo, el ancla en las maniobras de fondeo. También conocido como cabrestante

MODELO	MEDIDAS – mm		PRESENTACIÓN
	“A”	“L”	
AMT-4861	24	25	Pieza

## Winch

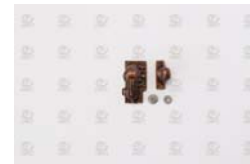
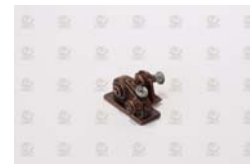

**MATERIAL:** Metal

**COLOR:** Natural

**ACABADO:** Envejecido

**APLICACIÓN:** Sirve para mover piezas de mucho peso, por ejemplo, el ancla en las maniobras de fondeo. También conocido como cabrestante

MODELO	MEDIDAS – mm		PRESENTACIÓN
	“A”	“L”	
AMT-4862	27	20	Pieza

## Torno para yate



**MATERIAL:** Latón

**COLOR:** Natural

MODELO	MEDIDAS – mm		PRESENTACIÓN
	“A”	“H”	
AMT-4865-14	14	14	Paquete de 2 pzs

## Winch



**MATERIAL:** Latón

**COLOR:** Natural

MODELO	MEDIDAS – mm		PRESENTACIÓN
	“L”	“H”	
AMT-4865-20	20	13	Pieza

## Winch



**MATERIAL:** Metal

**COLOR:** Natural

MODELO	MEDIDAS – mm		PRESENTACIÓN
	“L”	“H”	
AMT-4865-28	28	9	Pieza

## Cabrestante



**MATERIAL:** Latón

**COLOR:** Natural

MODELO	MEDIDAS – mm		PRESENTACIÓN
	“H”	“d”	
AMT-4866-01	4.5	5	Paquete de 2 pzs



## Cabrestante



**MATERIAL:** Latón

**COLOR:** Natural

MODELO	MEDIDAS – mm		PRESENTACIÓN
	“H”	“d”	
AMT-4866-02	6.5	8	Paquete de 2 pzs

## Cabrestante



**MATERIAL:** Latón

**COLOR:** Natural

MODELO	MEDIDAS – mm		PRESENTACIÓN
	“H”	“d”	
AMT-4866-03	12	12	Paquete de 2 pzs

## Resorte



**MATERIAL:** Metal

**COLOR:** Natural

MODELO	MEDIDAS – mm		PRESENTACIÓN
	“L”	“d”	
AMT-4868-10	10	2.5	Paquete de 10 pzs

## Resorte



**MATERIAL:** Metal

**COLOR:** Natural

MODELO	MEDIDAS - mm		PRESENTACIÓN
	"L"	"d"	
AMT-4868-22	22	5	Paquete de 10 pzs

## Resorte



**MATERIAL:** Metal

**COLOR:** Natural

MODELO	MEDIDAS – mm		PRESENTACIÓN
	“L”	“d”	
AMT-4868-42	42	4	Paquete de 10 pzs

## Manivela



**MATERIAL:** Metal

**COLOR:** Natural

**ACABADO:** Envejecido

MODELO	MEDIDAS – mm	PRESENTACIÓN
	“d”	
AMT-4870	4.5	Paquete de 4 pzs
AMT-4871	8	Paquete de 4 pzs

## Manivela



**MATERIAL:** Resina

**COLOR:** Negro

MODELO	MEDIDAS – mm	PRESENTACIÓN
	“d”	
AMT-4872	5.5	Paquete de 4 pzs

## Cañón moderno



**MATERIAL:** Metal

**COLOR:** Natural

**ACABADO:** Envejecido

MODELO	MEDIDAS – mm		PRESENTACIÓN
	“L”	“d”	
AMT-4890	35	10	Paquete de 2 pzs



## Cañón moderno



**MATERIAL:** Metal

**COLOR:** Natural

MODELO	MEDIDAS – mm		PRESENTACIÓN
	“L”	“d”	
AMT-4890-01	13	5	Paquete de 2 pzs

## Cañón antiaéreo monotubo



MATERIAL: Latón

COLOR: Natural

MODELO	MEDIDAS – mm		PRESENTACIÓN
	“L”	“d”	
AMT-4893	16	4	Paquete de 2 pzs

## Cañón antiaéreo bitubo



MATERIAL: Latón

COLOR: Natural

MODELO	MEDIDAS – mm		PRESENTACIÓN
	“L”	“d”	
AMT-4894	16	4	Paquete de 2 pzs

## Cañón antiaéreo monotubo



**MATERIAL:** Latón

**COLOR:** Natural

MODELO	MEDIDAS – mm		PRESENTACIÓN
	“L”	“d”	
AMT-4895	24	5	Paquete de 2 pzs

## Cañón antiaéreo bitubo



MATERIAL: Latón

COLOR: Natural

MODELO	MEDIDAS – mm		PRESENTACIÓN
	“L”	“d”	
AMT-4896	24	5	Paquete de 2 pzs

## Tensor



**MATERIAL:** Latón

**COLOR:** Natural

**APLICACIÓN:** Es la combinación de dos tornillos de hilo encontrado y un cuerpo de unión, que sirve para enlazar las dos partes y producir una tensión considerable

MODELO	MEDIDAS – mm			PRESENTACIÓN
	“L”	“L1”	“d”	
AMT-4900-12	16	12	1.5	Paquete de 5 pzs

## Tensor



**MATERIAL:** Latón

**COLOR:** Natural

**APLICACIÓN:** Es la combinación de dos tornillos de hilo encontrado y un cuerpo de unión, que sirve para enlazar las dos partes y producir una tensión considerable

MODELO	MEDIDAS – mm			PRESENTACIÓN
	“L”	“L1”	“d”	
AMT-4900-17	21	17	2	Paquete de 5 pzs

## Tensor



**MATERIAL:** Latón

**COLOR:** Natural

**APLICACIÓN:** Es la combinación de dos tornillos de hilo encontrado y un cuerpo de unión, que sirve para enlazar las dos partes y producir una tensión considerable

MODELO	MEDIDAS – mm			PRESENTACIÓN
	“L”	“L1”	“d”	
AMT-4900-22	26	22	2.5	Paquete de 5 pzs



## Tensor



**MATERIAL:** Latón

**COLOR:** Natural

**APLICACIÓN:** Es la combinación de dos tornillos de hilo encontrado y un cuerpo de unión, que sirve para enlazar las dos partes y producir una tensión considerable

MODELO	MEDIDAS – mm			PRESENTACIÓN
	“L”	“L1”	“d”	
AMT-4900-30	34	30	3	Paquete de 5 pzs

## Cadenote para tensor



**MATERIAL:** Latón

**COLOR:** Natural

**APLICACIÓN:** Sirve de sostén a los obenques y burdas, cada cadenote cierra uno de los cables que soportan la arboladura de un velero

MODELO	MEDIDAS – mm		PRESENTACIÓN
	“A”	“L”	
AMT-4905-01	2	20	Paquete de 10 pzs

## Cadenote para tensor

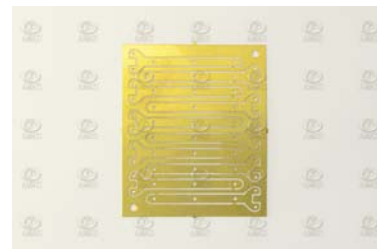
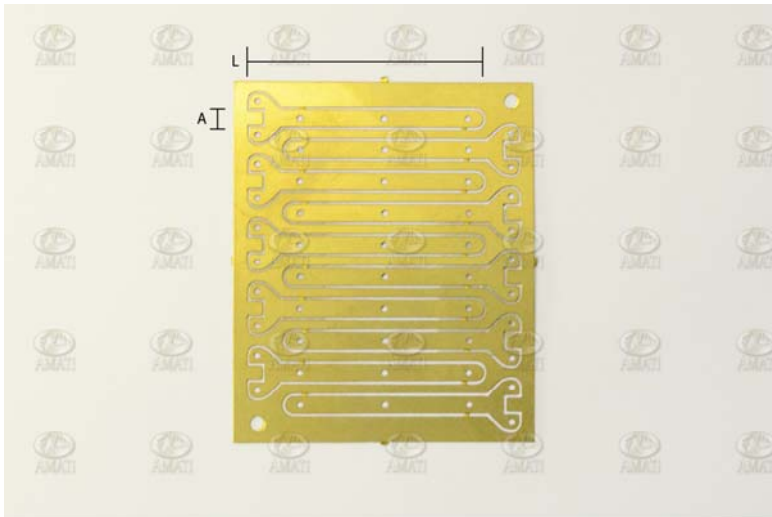

**MATERIAL:** Latón

**COLOR:** Natural

**APLICACIÓN:** Es la combinación de dos tornillos de hilo encontrado y un cuerpo de unión, que sirve para enlazar las dos partes y producir una tensión considerable

MODELO	MEDIDAS – mm		PRESENTACIÓN
	“A”	“L”	
AMT-4905-02	2	30	Paquete de 10 pzs

## Bitá



**MATERIAL:** Latón

**COLOR:** Natural

**APLICACIÓN:** Postes de madera o hierro que, asegurados a la cubierta en las proximidades de la proa, sirven para dar vuelta a los cabos del ancla cuando se fondea la nave

MODELO	MEDIDAS – mm			PRESENTACIÓN
	“H”	“d”	“d1”	
AMT-4909-01	4.5	6	2	Paquete de 20 pzs

## Bitá



**MATERIAL:** Latón

**COLOR:** Natural

**APLICACIÓN:** Postes de madera o hierro que, asegurados a la cubierta en las proximidades de la proa, sirven para dar vuelta a los cabos del ancla cuando se fondea la nave

MODELO	MEDIDAS – mm			PRESENTACIÓN
	“H”	“d”	“d1”	
AMT-4909-02	6.5	4	2	Paquete de 20 pzs

## Bitá



MATERIAL:	Metal
COLOR:	Natural
ACABADO:	Envejecido
APLICACIÓN:	Postes de madera o hierro que, asegurados a la cubierta en las proximidades de la proa, sirven para dar vuelta a los cables del ancla cuando se fondea la nave

MODELO	MEDIDAS – mm			PRESENTACIÓN
	“A”	“L”	“H”	
AMT-4909-03	4	10	5	Paquete de 10 pzs

## Bitá

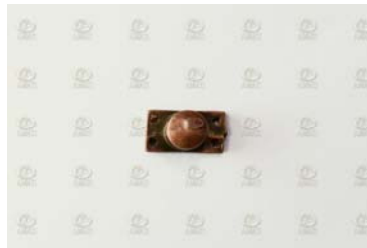

MATERIAL:	Metal
COLOR:	Natural
ACABADO:	Envejecido
APLICACIÓN:	Postes de madera o hierro que, asegurados a la cubierta en las proximidades de la proa, sirven para dar vuelta a los cables del ancla cuando se fondea la nave

MODELO	MEDIDAS – mm			PRESENTACIÓN
	“A”	“L”	“H”	
AMT-4909-04	6	12	8	Paquete de 10 pzs

## Bitá doble

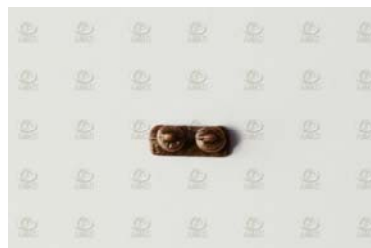
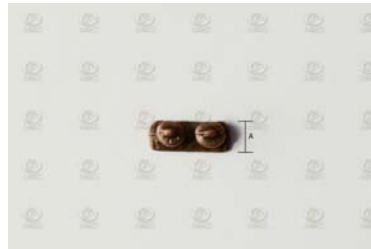

MATERIAL:	Metal
COLOR:	Natural
ACABADO:	Envejecido
APLICACIÓN:	Postes de madera o hierro que, asegurados a la cubierta en las proximidades de la proa, sirven para dar vuelta a los cables del ancla cuando se fondea la nave

MODELO	MEDIDAS – mm			PRESENTACIÓN
	“A”	“L”	“H”	
AMT-4909-06	3	7	3.5	Paquete de 10 pzs



## Bitá doble

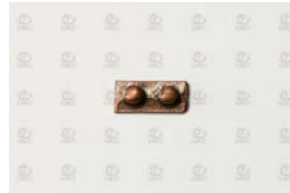

MATERIAL:	Metal
COLOR:	Natural
ACABADO:	Envejecido
APLICACIÓN:	Postes de madera o hierro que, asegurados a la cubierta en las proximidades de la proa, sirven para dar vuelta a los cables del ancla cuando se fondea la nave

MODELO	MEDIDAS – mm			PRESENTACIÓN
	“A”	“L”	“H”	
AMT-4909-07	4	10	5	Paquete de 10 pzs

## Bitá doble



MATERIAL:	Metal
COLOR:	Natural
ACABADO:	Envejecido
APLICACIÓN:	Postes de madera o hierro que, asegurados a la cubierta en las proximidades de la proa, sirven para dar vuelta a los cables del ancla cuando se fondea la nave

MODELO	MEDIDAS – mm			PRESENTACIÓN
	“A”	“L”	“H”	
AMT-4909-08	6	22	8	Paquete de 10 pzs

## Bitá simple



- MATERIAL:** Madera de balsa
- COLOR:** Natural
- APLICACIÓN:** Postes de madera o hierro que, asegurados a la cubierta en las proximidades de la proa, sirven para dar vuelta a los cabos del ancla cuando se fondea la nave

MODELO	MEDIDAS – mm		PRESENTACIÓN
	“H”	“d”	
AMT-4910-05	5	3	Paquete de 20 pzs

## Bitá simple



**MATERIAL:** Madera de balsa

**COLOR:** Natural

**APLICACIÓN:** Postes de madera o hierro que, asegurados a la cubierta en las proximidades de la proa, sirven para dar vuelta a los cabos del ancla cuando se fondea la nave

MODELO	MEDIDAS – mm			PRESENTACIÓN
	“L”	“H”	“d”	
AMT-4910-09	5	9	4.5	Paquete de 20 pzs

## Bitá cruzada



**MATERIAL:** Latón

**COLOR:** Natural

**APLICACIÓN:** Postes de madera o hierro que, asegurados a la cubierta en las proximidades de la proa, sirven para dar vuelta a los cabos del ancla cuando se fondea la nave

MODELO	MEDIDAS – mm				PRESENTACIÓN
	“H”	“d”	“d1”	“d2”	
AMT-4911	4	3	2	1	Paquete de 2 pzs

## Bitá cruzada



<b>MATERIAL:</b>	Metal
<b>COLOR:</b>	Natural
<b>ACABADO:</b>	Envejecido
<b>APLICACIÓN:</b>	Postes de madera o hierro que, asegurados a la cubierta en las proximidades de la proa, sirven para dar vuelta a los cables del ancla cuando se fondea la nave

MODELO	MEDIDAS – mm			PRESENTACIÓN
	“L”	“H”	“d”	
AMT-4912	7	10	5	Paquete de 10 pzs

## Pasacabo



**MATERIAL:** Metal

**COLOR:** Natural

**ACABADO:** Envejecido

**APLICACIÓN:** Sirve para abrir los cabos (sogas) que se entrelazan uno con otro. Conocido como guías de estacha

MODELO	MEDIDAS – mm			PRESENTACIÓN
	“A”	“L”	“H”	
AMT-4920-09	2	9	3	Paquete de 10 pzs

## Pasacabo



**MATERIAL:** Metal

**COLOR:** Natural

**ACABADO:** Envejecido

**APLICACIÓN:** Sirve para abrir los cabos (sogas) que se entrelazan uno con otro. Conocido como guías de estacha

MODELO	MEDIDAS – mm			PRESENTACIÓN
	“A”	“L”	“H”	
AMT-4920-12	2.5	12	4	Paquete de 10 pzs



## Pasacabo



**MATERIAL:** Metal

**COLOR:** Natural

**ACABADO:** Envejecido

**APLICACIÓN:** Sirve para abrir los cabos (sogas) que se entrelazan uno con otro. Conocido como guías de estacha

MODELO	MEDIDAS – mm			PRESENTACIÓN
	“A”	“L”	“H”	
AMT-4920-14	3	14	5	Paquete de 10 pzs

## Pasacabo



**MATERIAL:** Metal

**COLOR:** Natural

**ACABADO:** Envejecido

**APLICACIÓN:** Sirve para abrir los cabos (sogas) que se entrelazan uno con otro. Conocido como guías de estacha

MODELO	MEDIDAS – mm			PRESENTACIÓN
	“A”	“L”	“H”	
AMT-4922-20	4	20	6	Paquete de 10 pzs

## Pasacabo



**MATERIAL:** Metal

**COLOR:** Natural

**ACABADO:** Envejecido

**APLICACIÓN:** Sirve para abrir los cabos (sogas) que se entrelazan uno con otro. Conocido como guías de estacha

MODELO	MEDIDAS – mm			PRESENTACIÓN
	“A”	“L”	“H”	
AMT-4922-27	5	27	7	Paquete de 10 pzs

## Pasacabo rodillo sencillo

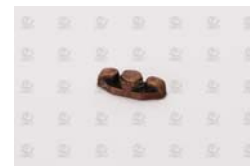
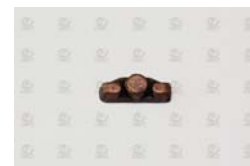

**MATERIAL:** Metal

**COLOR:** Natural

**ACABADO:** Envejecido

**APLICACIÓN:** Sirve para abrir los cabos (sogas) que se entrelazan uno con otro. Conocido como guías de estacha

MODELO	MEDIDAS – mm			PRESENTACIÓN
	“A”	“L”	“H”	
AMT-4923-07	2.5	7	2	Paquete de 10 pzs

## Pasacabo rodillo doble

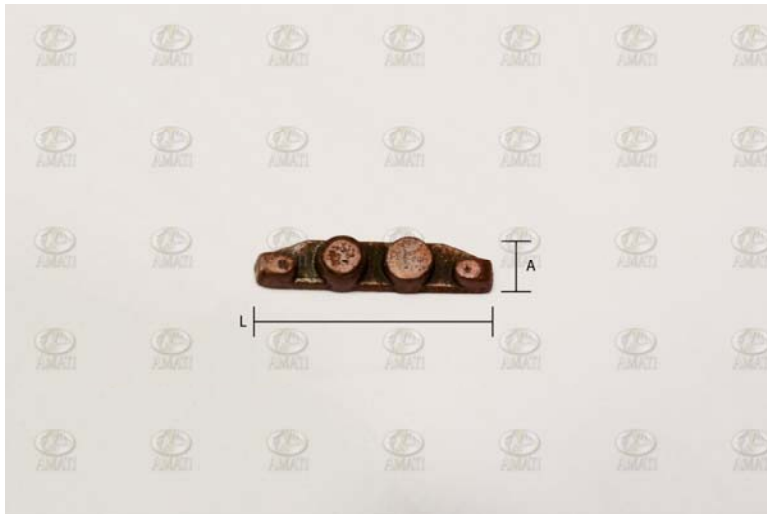

**MATERIAL:** Metal

**COLOR:** Natural

**ACABADO:** Envejecido

**APLICACIÓN:** Sirve para abrir los cabos (sogas) que se entrelazan uno con otro. Conocido como guías de estacha

MODELO	MEDIDAS – mm			PRESENTACIÓN
	“A”	“L”	“H”	
AMT-4923-12	3	12	2	Paquete de 10 pzs

## Pasacabo rodillo triple



**MATERIAL:** Metal

**COLOR:** Natural

**ACABADO:** Envejecido

**APLICACIÓN:** Sirve para abrir los cabos (sogas) que se entrelazan uno con otro. Conocido como guías de estacha

MODELO	MEDIDAS – mm			PRESENTACIÓN
	“A”	“L”	“H”	
AMT-4923-16	3.5	16	2	Paquete de 10 pzs

## Pasacabo cromado



**MATERIAL:** Metal

**COLOR:** Natural

**APLICACIÓN:** Sirve para abrir los cabos (sogas) que se entrelazan uno con otro. Conocido como guías de estacha

MODELO	MEDIDAS – mm			PRESENTACIÓN
	“A”	“L”	“H”	
AMT-4925-09	2	9	1	Paquete de 10 pzs
AMT-4925-12	3	12	4	Paquete de 10 pzs
AMT-4925-14	3.5	14	5	Paquete de 10 pzs

## Pasacabo con bita



**MATERIAL:** Metal

**COLOR:** Natural

**ACABADO:** Envejecido

**APLICACIÓN:** Sirve para abrir los cabos (sogas) que se entrelazan uno con otro. Conocido como guías de estacha

MODELO	MEDIDAS – mm			PRESENTACIÓN
	“A”	“L”	“H”	
AMT-4926-17	3	17	4	Paquete de 10 pzs



## Pasacabo con bita



**MATERIAL:** Metal

**COLOR:** Natural

**ACABADO:** Envejecido

**APLICACIÓN:** Sirve para abrir los cabos (sogas) que se entrelazan uno con otro. Conocido como guías de estacha

MODELO	MEDIDAS – mm			PRESENTACIÓN
	“A”	“L”	“H”	
AMT-4926-22	4	22	5	Paquete de 10 pzs

## Pasacabo de proa



**MATERIAL:** Metal

**COLOR:** Natural

**ACABADO:** Envejecido

**APLICACIÓN:** Sirve para abrir los cabos (sogas) que se entrelazan uno con otro. Conocido como guías de estacha

MODELO	MEDIDAS – mm				PRESENTACIÓN
	“A”	“L”	“H”	“d”	
AMT-4928	3	18	15	1.5	Paquete de 2 pzs

## Pasacabo de proa

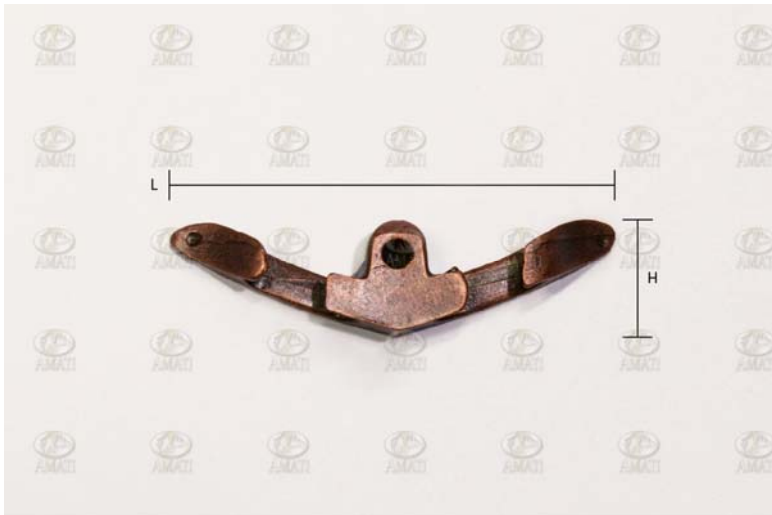

**MATERIAL:** Metal

**COLOR:** Natural

**ACABADO:** Envejecido

**APLICACIÓN:** Sirve para abrir los cabos (sogas) que se entrelazan uno con otro. Conocido como guías de estacha

MODELO	MEDIDAS – mm			PRESENTACIÓN
	“A”	“L”	“H”	
AMT-4929	3	30	8	Paquete de 2 pzs

## Pasacabo cromado



**MATERIAL:** Metal

**COLOR:** Natural

**APLICACIÓN:** Sirve para abrir los cabos (sogas) que se entrelazan uno con otro. Conocido como guías de estacha

MODELO	MEDIDAS – mm				PRESENTACIÓN
	“A”	“L”	“H”	“H1”	
AMT-4930	8	10	8	3	Paquete de 4 pzs

## Pasacabo cerrado



**MATERIAL:** Metal

**COLOR:** Natural

**ACABADO:** Envejecido

**APLICACIÓN:** Sirve para abrir los cabos (sogas) que se entrelazan uno con otro. Conocido como guías de estacha

MODELO	MEDIDAS – mm			PRESENTACIÓN
	“A”	“L”	“H”	
AMT-4931	4	13	6	Paquete de 10 pzs

## Cornamusa

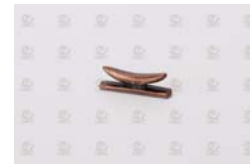

**MATERIAL:** Metal

**COLOR:** Natural

**ACABADO:** Envejecido

**APLICACIÓN:** Sirve para amarrar cabos (sogas)

MODELO	MEDIDAS – mm			PRESENTACIÓN
	“A”	“L”	“H”	
AMT-4935-05	2	5	2.5	Paquete de 10 pzs

## Cornamusa

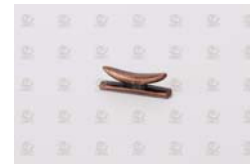

**MATERIAL:** Metal

**COLOR:** Natural

**ACABADO:** Envejecido

**APLICACIÓN:** Sirve para amarrar cabos (sogas)

MODELO	MEDIDAS – mm			PRESENTACIÓN
	“A”	“L”	“H”	
AMT-4935-07	2	7	2	Paquete de 10 pzs

## Cornamusa

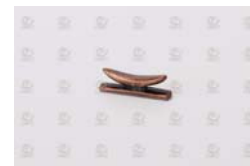

**MATERIAL:** Metal

**COLOR:** Natural

**ACABADO:** Envejecido

**APLICACIÓN:** Sirve para amarrar cabos (sogas)

MODELO	MEDIDAS – mm			PRESENTACIÓN
	“A”	“L”	“H”	
AMT-4935-12	3	12	4	Paquete de 10 pzs



## Cornamusa

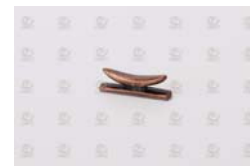

**MATERIAL:** Metal

**COLOR:** Natural

**ACABADO:** Envejecido

**APLICACIÓN:** Sirve para amarrar cabos (sogas)

MODELO	MEDIDAS – mm			PRESENTACIÓN
	“A”	“L”	“H”	
AMT-4935-16	3	16	5	Paquete de 10 pzs

## Cornamusa con orificio



**MATERIAL:** Metal

**COLOR:** Natural

**ACABADO:** Envejecido

**APLICACIÓN:** Sirve para amarrar cabos (sogas)

MODELO	MEDIDAS – mm			PRESENTACIÓN
	“A”	“L”	“H”	
AMT-4936	1.5	10	5	Paquete de 10 pzs

## Cornamusa con orificio



**MATERIAL:** Metal

**COLOR:** Natural

**APLICACIÓN:** Sirve para amarrar cabos (sogas)

MODELO	MEDIDAS – mm				PRESENTACIÓN
	“A”	“L”	“H”	“H1”	
AMT-4937-09	3	9	4	2	Paquete de 10 pzs

## Cornamusa con orificio

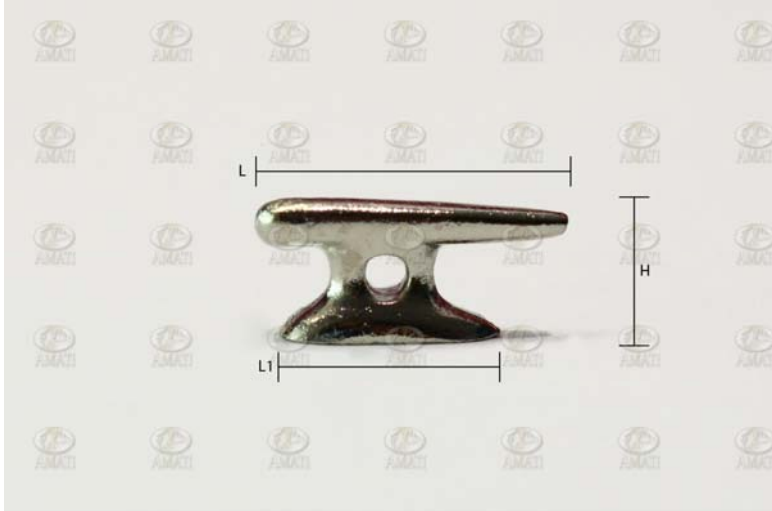

**MATERIAL:** Metal

**COLOR:** Natural

**APLICACIÓN:** Sirve para amarrar cabos (sogas)

MODELO	MEDIDAS – mm			PRESENTACIÓN
	“L”	“L1”	“H”	
AMT-4937-15	15	10	7	Paquete de 10 pzs

## Cornamusa con orificio



**MATERIAL:** Metal

**COLOR:** Natural

**APLICACIÓN:** Sirve para amarrar cabos (sogas)

MODELO	MEDIDAS – mm			PRESENTACIÓN
	“L”	“L1”	“H”	
AMT-4937-24	24	15	10	Paquete de 10 pzs

## Escotilla



<b>MATERIAL:</b>	Metal
<b>COLOR:</b>	Natural
<b>ACABADO:</b>	Envejecido
<b>APLICACIÓN:</b>	Aberturas que hay en diversas cubiertas para el servicio del navío

MODELO	MEDIDAS – mm	PRESENTACIÓN
	“L”	
AMT-4938-08	8	Paquete de 10 pzs

## Escotilla



<b>MATERIAL:</b>	Metal
<b>COLOR:</b>	Natural
<b>ACABADO:</b>	Envejecido
<b>APLICACIÓN:</b>	Aberturas que hay en diversas cubiertas para el servicio del navío

MODELO	MEDIDAS – mm		PRESENTACIÓN
	“L”	“H”	
AMT-4938-12	11	12	Paquete de 10 pzs

## Compuerta



<b>MATERIAL:</b>	Metal
<b>COLOR:</b>	Natural
<b>ACABADO:</b>	Envejecido
<b>APLICACIÓN:</b>	Puerta pequeña y fuerte, que se desliza por correderas, colocándose en canales, diques, etc., para dar entrada o cortar el paso del agua

MODELO	MEDIDAS – mm		PRESENTACIÓN
	“L”	“H”	
AMT-4939-18	10	18	Paquete de 10 pzs



## Compuerta



MATERIAL:	Metal
COLOR:	Natural
ACABADO:	Envejecido
APLICACIÓN:	Puerta pequeña y fuerte, que se desliza por correderas, colocándose en canales, diques, etc., para dar entrada o cortar el paso del agua

MODELO	MEDIDAS – mm		PRESENTACIÓN
	“L”	“H”	
AMT-4939-25	13	25	Paquete de 10 pzs

## Portillo circular



**MATERIAL:** Latón

**COLOR:** Natural

MODELO	MEDIDAS – mm		PRESENTACIÓN
	“d”	“d1”	
AMT-4940-05	5	4	Paquete de 20 pzs

## Portillo circular



**MATERIAL:** Latón

**COLOR:** Natural

MODELO	MEDIDAS – mm		PRESENTACIÓN
	“d”	“d1”	
AMT-4940-07	7	6	Paquete de 20 pzs

## Portillo circular

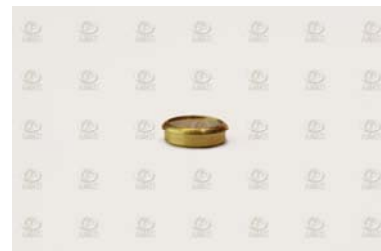

MATERIAL: Latón

COLOR: Natural

MODELO	MEDIDAS – mm		PRESENTACIÓN
	“d”	“d1”	
AMT-4940-09	9	8	Paquete de 20 pzs

Portillo circular



MATERIAL: Latón

COLOR: Natural

MODELO	MEDIDAS – mm		PRESENTACIÓN
	“d”	“d1”	
AMT-4940-12	12	11	Paquete de 20 pzs

## Portillo circular

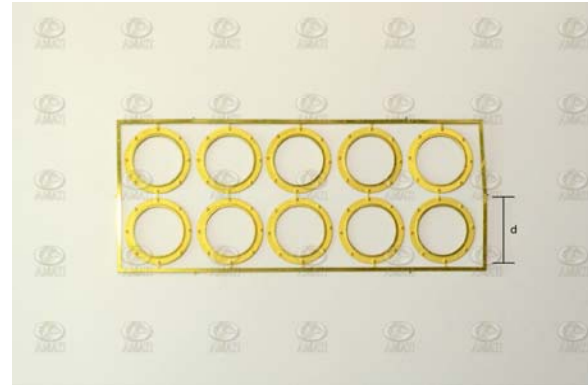
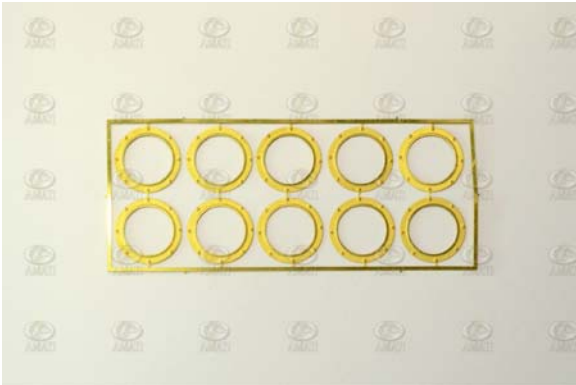

MATERIAL: Latón

COLOR: Natural

MODELO	MEDIDAS – mm	PRESENTACIÓN
	“d”	
AMT-4940-15	15	Paquete de 10 pzs

## Ventana circular



MATERIAL: Latón

COLOR: Natural

MODELO	MEDIDAS – mm		PRESENTACIÓN
	“d”	“d1”	
AMT-4941-15	20	15	Paquete de 5 pzs

## Portillo circular



**MATERIAL:** Metal

**COLOR:** Natural

MODELO	MEDIDAS – mm		PRESENTACIÓN
	“d”	“d1”	
AMT-4942-10	10	9	Paquete de 20 pzs



Portillo circular



MATERIAL: Metal

COLOR: Natural

MODELO	MEDIDAS – mm		PRESENTACIÓN
	“d”	“d1”	
AMT-4942-12	12	11	Paquete de 20 pzs

## Ojillo



**MATERIAL:** Latón

**COLOR:** Natural

MODELO	MEDIDAS – mm		PRESENTACIÓN
	“d”	“d1”	
AMT-4945	2	1.2	Paquete de 50 pzs

## Ojillo



MATERIAL: Latón

COLOR: Natural

MODELO	MEDIDAS – mm		PRESENTACIÓN
	“d”	“d1”	
AMT-4945-01	2.5	1.5	Paquete de 50 pzs

## Ojillo



MATERIAL: Latón

COLOR: Natural

MODELO	MEDIDAS – mm		PRESENTACIÓN
	“d”	“d1”	
AMT-4945-02	3.5	2	Paquete de 50 pzs

## Ojillo



MATERIAL: Latón

COLOR: Natural

MODELO	MEDIDAS – mm		PRESENTACIÓN
	“d”	“d1”	
AMT-4945-03	5	3	Paquete de 50 pzs

## Ojillo niquelado



**MATERIAL:** Metal

**COLOR:** Natural

MODELO	MEDIDAS – mm		PRESENTACIÓN
	“d”	“d1”	
AMT-4946-01	2.5	1.5	Paquete de 50 pzs

## Ojillo niquelado



**MATERIAL:** Metal

**COLOR:** Natural

MODELO	MEDIDAS – mm		PRESENTACIÓN
	“d”	“d1”	
AMT-4946-02	3	2	Paquete de 50 pzs

## Ojillo niquelado



**MATERIAL:** Metal

**COLOR:** Natural

MODELO	MEDIDAS – mm		PRESENTACIÓN
	“d”	“d1”	
AMT-4946-03	5	3	Paquete de 50 pzs



## Ojillo oval



MATERIAL: Latón

COLOR: Natural

MODELO	MEDIDAS – mm		PRESENTACIÓN
	“L”	“H”	
AMT-4947-02	13	8	Paquete de 20 pzs

## Tragaluz

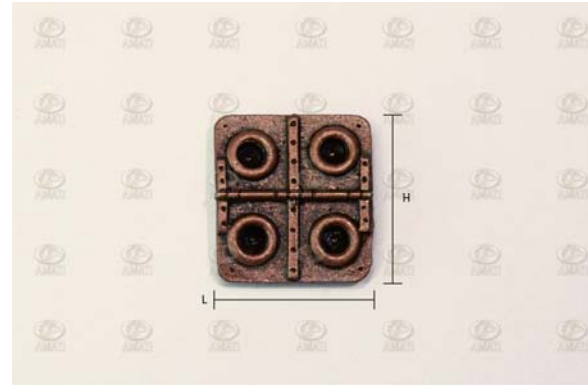

MATERIAL: Metal

COLOR: Natural

ACABADO: Envejecido

MODELO	MEDIDAS – mm		PRESENTACIÓN
	“L”	“H”	
AMT-4948-16	15	16	Paquete de 2 pzs

## Tragaluz

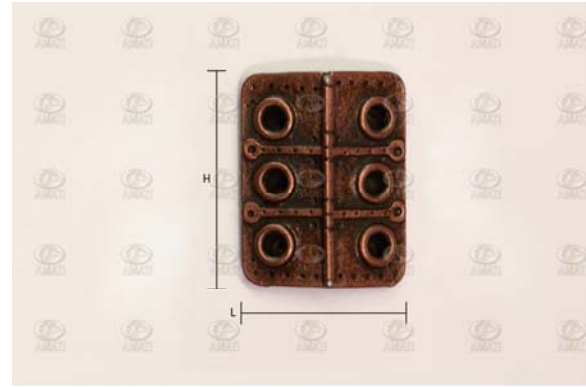

**MATERIAL:** Metal

**COLOR:** Natural

**ACABADO:** Envejecido

MODELO	MEDIDAS – mm		PRESENTACIÓN
	“L”	“H”	
AMT-4948-24	19	24	Paquete de 2 pzs

## Candelero plano

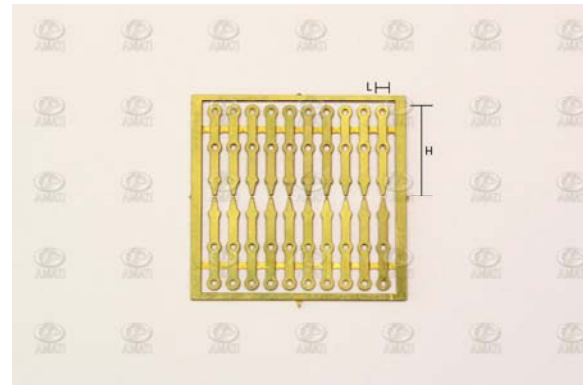
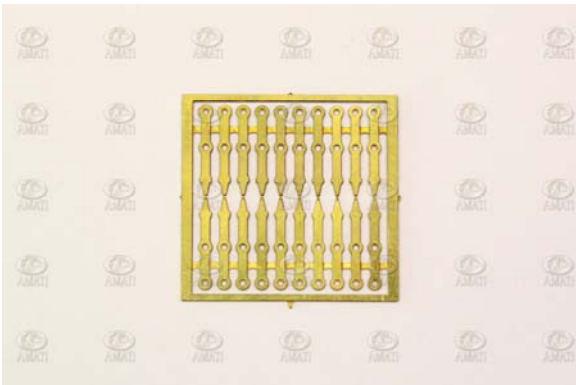

**MATERIAL:** Latón

**COLOR:** Natural

**APLICACIÓN:** Es el armazón de hierro o madera que sostiene cualquiera de los faroles de popa

MODELO	MEDIDAS – mm		PRESENTACIÓN
	“L”	“H”	
AMT-4949-10	2	10	Paquete de 10 pzs

## Candelero

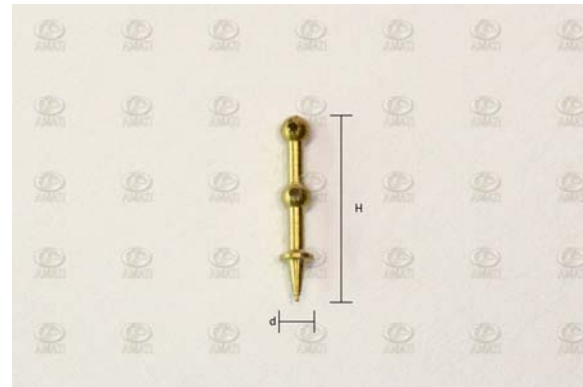

**MATERIAL:** Latón

**COLOR:** Natural

**APLICACIÓN:** Es el armazón de hierro o madera que sostiene cualquiera de los faroles de popa

MODELO	MEDIDAS – mm		PRESENTACIÓN
	“H”	“d”	
AMT-4950-06	6	1	Paquete de 10 pzs

## Candelero



**MATERIAL:** Latón

**COLOR:** Natural

**APLICACIÓN:** Es el armazón de hierro o madera que sostiene cualquiera de los faroles de popa

MODELO	MEDIDAS – mm		PRESENTACIÓN
	“H”	“d”	
AMT-4950-10	10	1	Paquete de 10 pzs

## Candelero

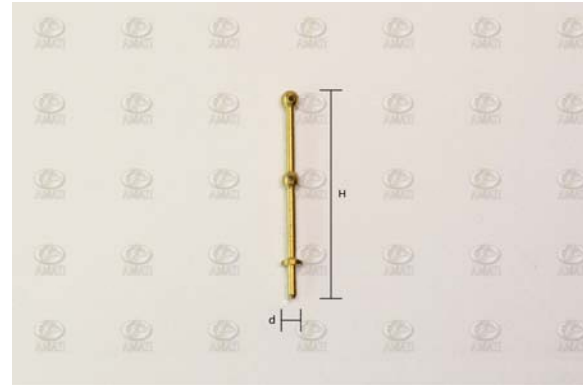

**MATERIAL:** Latón

**COLOR:** Natural

**APLICACIÓN:** Es el armazón de hierro o madera que sostiene cualquiera de los faroles de popa

MODELO	MEDIDAS – mm		PRESENTACIÓN
	“H”	“d”	
AMT-4950-20	20	1	Paquete de 10 pzs

## Candelero

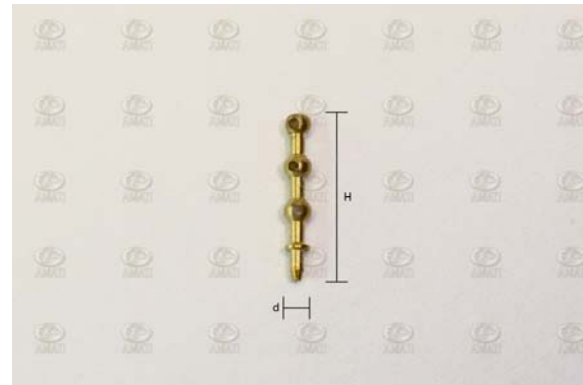

**MATERIAL:** Latón

**COLOR:** Natural

**APLICACIÓN:** Es el armazón de hierro o madera que sostiene cualquiera de los faroles de popa

MODELO	MEDIDAS – mm		PRESENTACIÓN
	“H”	“d”	
AMT-4951	8	1	Paquete de 10 pzs



## Candelero

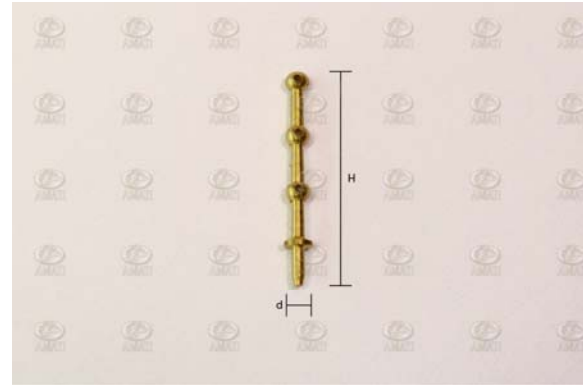

**MATERIAL:** Latón

**COLOR:** Natural

**APLICACIÓN:** Es el armazón de hierro o madera que sostiene cualquiera de los faroles de popa

MODELO	MEDIDAS – mm		PRESENTACIÓN
	“H”	“d”	
AMT-4952	12	1	Paquete de 10 pzs

## Candelero

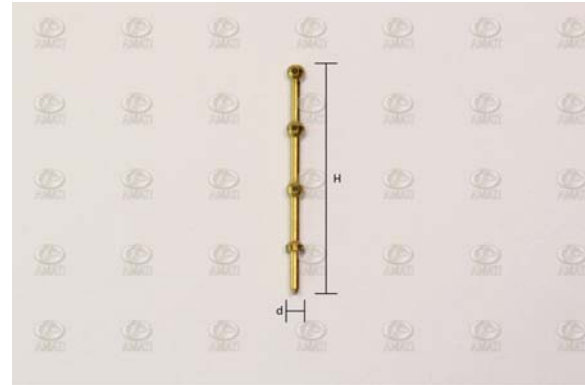

**MATERIAL:** Latón

**COLOR:** Natural

**APLICACIÓN:** Es el armazón de hierro o madera que sostiene cualquiera de los faroles de popa

MODELO	MEDIDAS – mm		PRESENTACIÓN
	“H”	“d”	
AMT-4953	20	1	Paquete de 10 pzs

## Carcasa para Soga

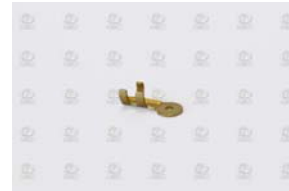
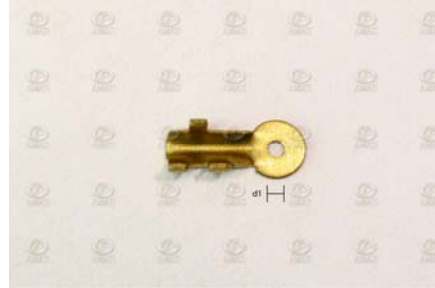
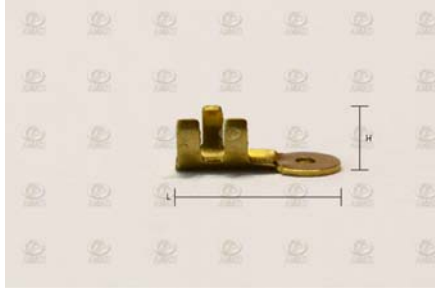

**MATERIAL:** Latón

**COLOR:** Natural

**APLICACIÓN:** Sirve para proteger el borde de los cabos (sogas)

MODELO	MEDIDAS – mm			PRESENTACIÓN
	“L”	“H”	“d”	
AMT-4954-01	7	3	1	Paquete de 10 pzs

## Terminal para sogá



**MATERIAL:** Metal

**COLOR:** Natural

**APLICACIÓN:** Sirve para proteger el borde de los cabos (sogas)

MODELO	MEDIDAS – mm		PRESENTACIÓN
	“L”	“d”	
AMT-4954-02	7	1	Paquete de 10 pzs

## Tornillo y tuerca



**MATERIAL:** Latón

**COLOR:** Natural

**APLICACIÓN:** Se utilizan en la quilla, que es la pieza que va de popa a proa por la parte inferior del barco y en que se asienta todo el armazón del navío

MODELO	MEDIDAS – mm		PRESENTACIÓN
	“L”	“d”	
AMT-4960-05	5	1	Paquete de 20 pzs

## Tornillo y tuerca



**MATERIAL:** Latón

**COLOR:** Natural

**APLICACIÓN:** Se utilizan en la quilla, que es la pieza que va de popa a proa por la parte inferior del barco y en que se asienta todo el armazón del navío

MODELO	MEDIDAS – mm		PRESENTACIÓN
	“L”	“d”	
AMT-4960-10	10	1.5	Paquete de 20 pzs

## Tornillo y tuerca



**MATERIAL:** Latón

**COLOR:** Natural

**APLICACIÓN:** Se utilizan en la quilla, que es la pieza que va de popa a proa por la parte inferior del barco y en que se asienta todo el armazón del navío

MODELO	MEDIDAS – mm		PRESENTACIÓN
	“L”	“d”	
AMT-4960-14	15	2	Paquete de 20 pzs

## Grillete

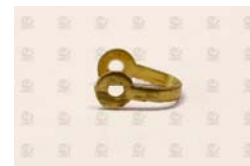

**MATERIAL:** Latón

**COLOR:** Natural

**APLICACIÓN:** Arco de hierro con dos agujeros por el cual se pasa un perno, con la que asegura una cadena a algún punto

MODELO	MEDIDAS – mm			PRESENTACIÓN
	“L”	“H”	“d”	
AMT-4965	3	5	2.5	Paquete de 10 pzs



## Escalera



MATERIAL: Latón

COLOR: Natural

MODELO	MEDIDAS - mm		PRESENTACIÓN
	"L"	"H"	
AMT-4970-03	3	100	Paquete de 10 pzs

## Escalera

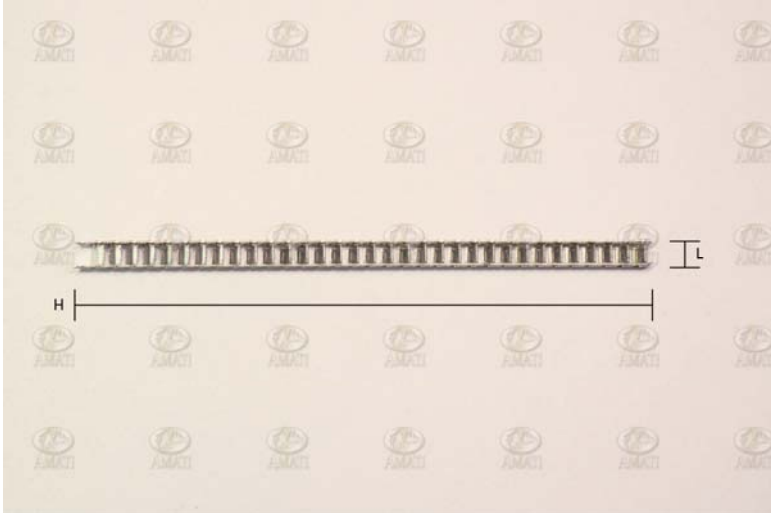

**MATERIAL:** Metal

**COLOR:** Natural

MODELO	MEDIDAS – mm		PRESENTACIÓN
	“L”	“H”	
AMT-4971-04	4	100	Paquete de 10 pzs

## Escalera



**MATERIAL:** Metal

**COLOR:** Natural

MODELO	MEDIDAS – mm		PRESENTACIÓN
	“L”	“H”	
AMT-4971-07	7	100	Paquete de 10 pzs

## Bote ballenero



MATERIAL: Plástico

COLOR: Café

MODELO	MEDIDAS – mm			PRESENTACIÓN
	“A”	“L”	“H”	
AMT-4975	16	65	10	Paquete de 2 pzs

## Bote ballenero



MATERIAL: Plástico

COLOR: Café

MODELO	MEDIDAS – mm			PRESENTACIÓN
	“A”	“L”	“H”	
AMT-4976	20	80	16	Paquete de 2 pzs

## Bote ballenero con cabina



**MATERIAL:** Plástico

**COLOR:** Café

MODELO	MEDIDAS – mm			PRESENTACIÓN
	“A”	“L”	“H”	
AMT-4977	16	65	16	Paquete de 2 pzs

## Moto lancha



MATERIAL: Plástico

COLOR: Café

MODELO	MEDIDAS – mm			PRESENTACIÓN
	“A”	“L”	“H”	
AMT-4978	24	80	22	Paquete de 2 pzs

## Eslabón

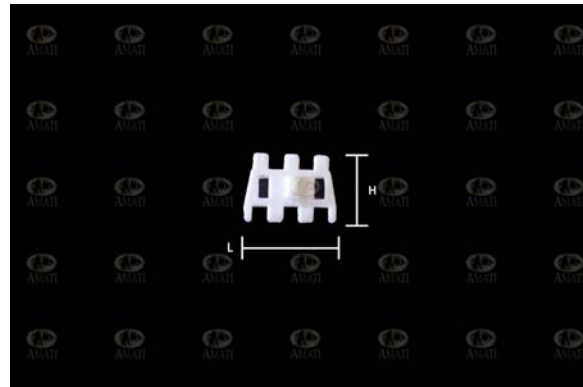
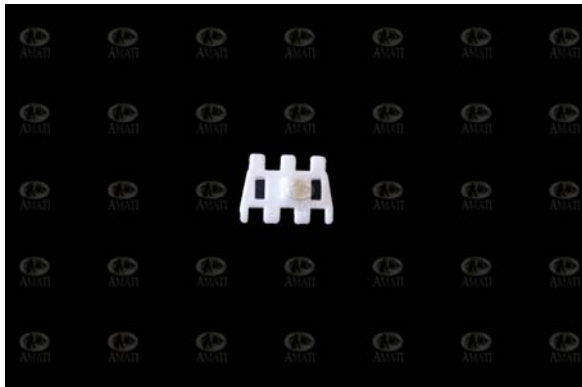

**MATERIAL:** Plástico

**COLOR:** Blanco

**APLICACIÓN:** Al unir varios eslabones, se genera la malla para la oruga (tanques y carros)

MODELO	MEDIDAS – mm		PRESENTACIÓN
	“L”	“H”	
AMT-5000	12	9	Paquete de 20 pzs



## Barril



**MATERIAL:** Plástico

**COLOR:** Gris

MODELO	MEDIDAS – mm		PRESENTACIÓN
	“H”	“d”	
AMT-5002	40	24	Paquete de 10 pzs

## Bidón

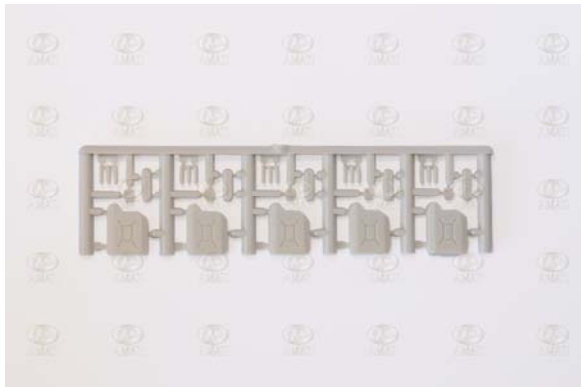

**MATERIAL:** Plástico

**COLOR:** Gris

**APLICACIÓN:** Recipiente con cierre hermético, que se utiliza para el transporte de líquidos o de sustancias

MODELO	MEDIDAS – mm		PRESENTACIÓN
	“L”	“H”	
AMT-5004	12	14	Paquete de 10 pzs

## Caja de municiones

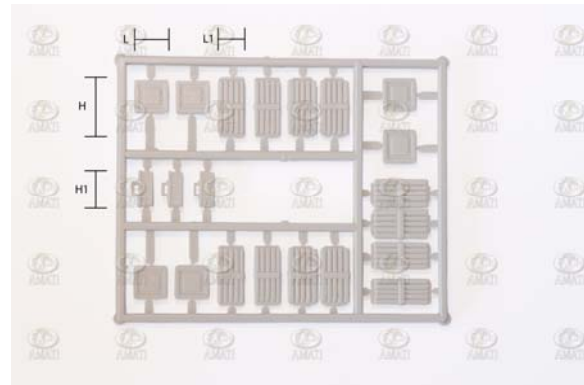
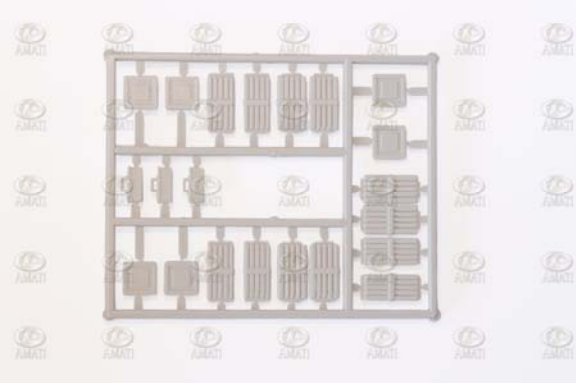

**MATERIAL:** Plástico

**COLOR:** Gris

MODELO	MEDIDAS – mm				PRESENTACIÓN
	“L”	“L1”	“H”	“H1”	
AMT-5008	10	8	18	11	Paquete de 12 pzs

## Ventana

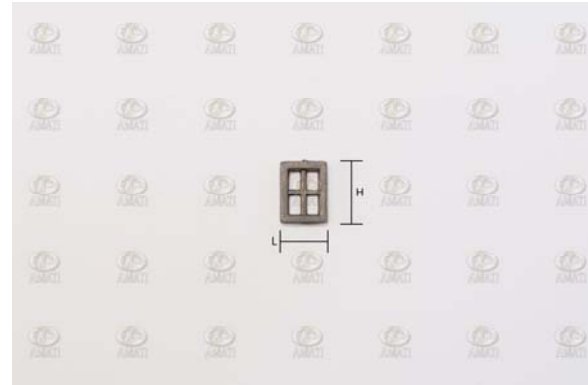

**MATERIAL:** Metal

**COLOR:** Natural

MODELO	MEDIDAS – mm		PRESENTACIÓN
	“L”	“H”	
AMT-5100-04	6.5	8.8	Paquete de 20 pzs

## Ventana

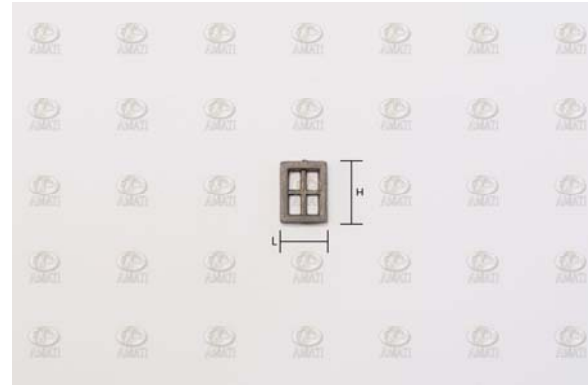

**MATERIAL:** Metal

**COLOR:** Natural

MODELO	MEDIDAS – mm		PRESENTACIÓN
	“L”	“H”	
AMT-5100-06	6.5	8.8	Paquete de 20 pzs

## Puerta

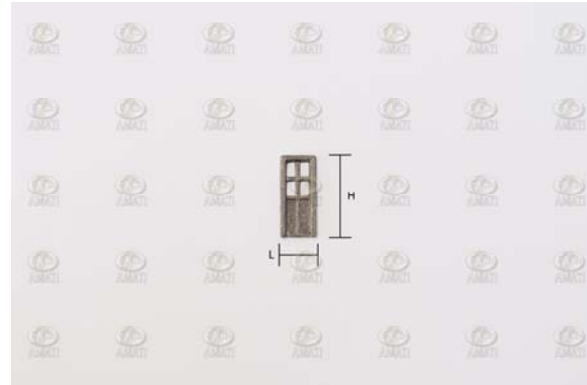

**MATERIAL:** Metal

**COLOR:** Natural

MODELO	MEDIDAS – mm		PRESENTACIÓN
	“L”	“H”	
AMT-5105-01	6.5	15	Paquete de 20 pzs

## Ornamento



**MATERIAL:** Metal

**COLOR:** Natural

**APLICACIÓN:** Decoración

MODELO	MEDIDAS – mm		PRESENTACIÓN
	“L”	“H”	
AMT-5301	7	45	Paquete de 2 pzs

## Ornamento



MATERIAL: Metal

COLOR: Natural

APLICACIÓN: Decoración

MODELO	MEDIDAS – mm			PRESENTACIÓN
	“A”	“L”	“H”	
AMT-5302	25	7	10	Paquete de 2 pzs



## Ornamento



MATERIAL: Metal

COLOR: Natural

APLICACIÓN: Decoración

MODELO	MEDIDAS – mm			PRESENTACIÓN
	“A”	“L”	“H”	
AMT-5303	10	8	10	Paquete de 2 pzs

## Ornamento



MATERIAL: Metal

COLOR: Natural

APLICACIÓN: Decoración

MODELO	MEDIDAS – mm			PRESENTACIÓN
	“A”	“L”	“H”	
AMT-5304	4.5	5	10	Paquete de 2 pzs

## Ornamento

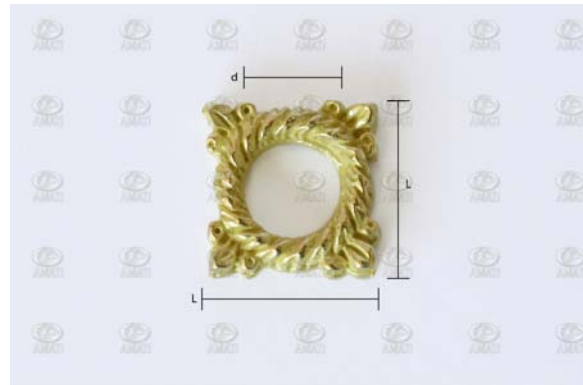

**MATERIAL:** Metal

**COLOR:** Natural

**APLICACIÓN:** Decoración

MODELO	MEDIDAS – mm		PRESENTACIÓN
	“L”	“d”	
AMT-5305	10	5	Paquete de 2 pzs

## Ornamento



**MATERIAL:** Metal

**COLOR:** Natural

**APLICACIÓN:** Decoración

MODELO	MEDIDAS – mm	PRESENTACIÓN
	“L”	
AMT-5306	12	Paquete de 2 pzs

## Ornamento



**MATERIAL:** Metal

**COLOR:** Natural

**APLICACIÓN:** Decoración

MODELO	MEDIDAS – mm			PRESENTACIÓN
	“L”	“H”	“d”	
AMT-5307	24	10	4	Paquete de 2 pzs

## Ornamento



**MATERIAL:** Metal

**COLOR:** Natural

**APLICACIÓN:** Decoración

MODELO	MEDIDAS – mm		PRESENTACIÓN
	“d”	“d1”	
AMT-5308	20	12	Paquete de 2 pzs

## Ornamento



**MATERIAL:** Metal

**COLOR:** Natural

**APLICACIÓN:** Decoración

MODELO	MEDIDAS – mm		PRESENTACIÓN
	“L”	“d”	
AMT-5309	8	2	Paquete de 2 pzs

## Ornamento



**MATERIAL:** Metal

**COLOR:** Natural

**APLICACIÓN:** Decoración

MODELO	MEDIDAS – mm			PRESENTACIÓN
	“L”	“H”	“d”	
AMT-5310	6	10	4	Paquete de 2 pzs



## Ornamento



**MATERIAL:** Metal

**COLOR:** Natural

**APLICACIÓN:** Decoración

MODELO	MEDIDAS – mm			PRESENTACIÓN
	“A”	“L”	“H”	
AMT-5311+12	5	12	25	Paquete de 1 par

## Ornamento



**MATERIAL:** Metal

**COLOR:** Natural

**APLICACIÓN:** Decoración

MODELO	MEDIDAS – mm		PRESENTACIÓN
	“L”	“H”	
AMT-5313+14	15	25	Paquete de 1 par

## Ornamento



**MATERIAL:** Metal

**COLOR:** Natural

**APLICACIÓN:** Decoración

MODELO	MEDIDAS – mm		PRESENTACIÓN
	“L”	“H”	
AMT-5315	54	58	Pieza

## Ornamento



**MATERIAL:** Metal

**COLOR:** Natural

**APLICACIÓN:** Decoración

MODELO	MEDIDAS – mm		PRESENTACIÓN
	“L”	“H”	
AMT-5316+17	30	18	Paquete de 1 par

## Ornamento



**MATERIAL:** Metal

**COLOR:** Natural

**APLICACIÓN:** Decoración

MODELO	MEDIDAS – mm		PRESENTACIÓN
	“L”	“H”	
AMT-5318+19	25	26	Paquete de 1 par

## Ornamento

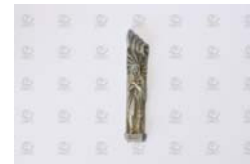

MATERIAL: Metal

COLOR: Natural

APLICACIÓN: Decoración

MODELO	MEDIDAS – mm		PRESENTACIÓN
	“L”	“H”	
AMT-5320+21	12	60	Paquete de 1 par

## Ornamento



**MATERIAL:** Metal

**COLOR:** Natural

**APLICACIÓN:** Decoración

MODELO	MEDIDAS – mm		PRESENTACIÓN
	“L”	“H”	
AMT-5322	5	40	Paquete de 2 pzs

## Ornamento



**MATERIAL:** Metal

**COLOR:** Natural

**APLICACIÓN:** Decoración

MODELO	MEDIDAS – mm		PRESENTACIÓN
	“L”	“H”	
AMT-5323	6	23	Paquete de 2 pzs



## Ornamento



**MATERIAL:** Metal

**COLOR:** Natural

**APLICACIÓN:** Decoración

MODELO	MEDIDAS – mm		PRESENTACIÓN
	“L”	“H”	
AMT-5324	6	22	Paquete de 2 pzs

## Ornamento



**MATERIAL:** Metal

**COLOR:** Natural

**APLICACIÓN:** Decoración

MODELO	MEDIDAS – mm		PRESENTACIÓN
	“L”	“H”	
AMT-5325	6	20	Paquete de 2 pzs

## Ornamento



**MATERIAL:** Metal

**COLOR:** Natural

**APLICACIÓN:** Decoración

MODELO	MEDIDAS – mm		PRESENTACIÓN
	“L”	“H”	
AMT-5326	5	20	Paquete de 2 pzs

## Ornamento



**MATERIAL:** Metal

**COLOR:** Natural

**APLICACIÓN:** Decoración

MODELO	MEDIDAS – mm		PRESENTACIÓN
	“L”	“H”	
AMT-5327	12	40	Paquete de 2 pzs

## Ornamento



**MATERIAL:** Metal

**COLOR:** Natural

**APLICACIÓN:** Decoración

MODELO	MEDIDAS – mm		PRESENTACIÓN
	“L”	“H”	
AMT-5328	15	60	Paquete de 2 pzs

## Ornamento



MATERIAL: Metal

COLOR: Natural

APLICACIÓN: Decoración

MODELO	MEDIDAS – mm			PRESENTACIÓN
	“A”	“L”	“H”	
AMT-5329	20	110	32	Pieza

## Ornamento



MATERIAL: Metal  
 COLOR: Natural  
 APLICACIÓN: Decoración

MODELO	MEDIDAS – mm	PRESENTACIÓN
	“L”	
AMT-5330	12	Paquete de 2 pzs

## Ornamento



**MATERIAL:** Metal

**COLOR:** Natural

**APLICACIÓN:** Decoración

MODELO	MEDIDAS – mm	PRESENTACIÓN
	“L”	
AMT-5331	12	Paquete de 2 pzs



## Ornamento



**MATERIAL:** Metal

**COLOR:** Natural

**APLICACIÓN:** Decoración

MODELO	MEDIDAS – mm	PRESENTACIÓN
	“L”	
AMT-5332	12	Paquete de 2 pzs

## Ornamento



**MATERIAL:** Metal

**COLOR:** Natural

**APLICACIÓN:** Decoración

MODELO	MEDIDAS – mm	PRESENTACIÓN
	“L”	
AMT-5333	12	Paquete de 2 pzs

## Ornamento



**MATERIAL:** Metal

**COLOR:** Natural

**APLICACIÓN:** Decoración

MODELO	MEDIDAS – mm	PRESENTACIÓN
	“L”	
AMT-5334	12	Paquete de 2 pzs

## Ornamento



**MATERIAL:** Metal

**COLOR:** Natural

**APLICACIÓN:** Decoración

MODELO	MEDIDAS – mm	PRESENTACIÓN
	“L”	
AMT-5335	12	Paquete de 2 pzs

## Ornamento



**MATERIAL:** Metal

**COLOR:** Natural

**APLICACIÓN:** Decoración

MODELO	MEDIDAS – mm	PRESENTACIÓN
	“L”	
AMT-5336	12	Paquete de 2 pzs

## Ornamento



**MATERIAL:** Metal

**COLOR:** Natural

**APLICACIÓN:** Decoración

MODELO	MEDIDAS – mm		PRESENTACIÓN
	“L”	“L1”	
AMT-5337	12	6	Paquete de 2 pzs

## Ornamento



**MATERIAL:** Metal

**COLOR:** Natural

**APLICACIÓN:** Decoración

MODELO	MEDIDAS – mm		PRESENTACIÓN
	“L”	“H”	
AMT-5338	66	10	Paquete de 2 pzs

## Ornamento



**MATERIAL:** Metal

**COLOR:** Natural

**APLICACIÓN:** Decoración

MODELO	MEDIDAS – mm			PRESENTACIÓN
	“H”	“d”	“d1”	
AMT-5339	20	5	2	Paquete de 2 pzs



## Ornamento



**MATERIAL:** Metal

**COLOR:** Natural

**APLICACIÓN:** Decoración

MODELO	MEDIDAS – mm		PRESENTACIÓN
	“L”	“H”	
AMT-5340	22	20	Paquete de 2 pzs

## Ornamento



**MATERIAL:** Metal

**COLOR:** Natural

**APLICACIÓN:** Decoración

MODELO	MEDIDAS – mm		PRESENTACIÓN
	“L”	“H”	
AMT-5341	30	10	Paquete de 2 pzs

## Ornamento



**MATERIAL:** Metal

**COLOR:** Natural

**APLICACIÓN:** Decoración

MODELO	MEDIDAS – mm		PRESENTACIÓN
	“L”	“H”	
AMT-5342	6	12	Paquete de 2 pzs

## Ornamento



**MATERIAL:** Metal

**COLOR:** Natural

**APLICACIÓN:** Decoración

MODELO	MEDIDAS – mm		PRESENTACIÓN
	“L”	“H”	
AMT-5343	13	15	Paquete de 2 pzs

## Ornamento



**MATERIAL:** Metal

**COLOR:** Natural

**APLICACIÓN:** Decoración

MODELO	MEDIDAS – mm		PRESENTACIÓN
	“L”	“d”	
AMT-5344	26	2	Paquete de 2 pzs

## Ornamento



**MATERIAL:** Metal

**COLOR:** Natural

**APLICACIÓN:** Decoración

MODELO	MEDIDAS – mm		PRESENTACIÓN
	“L”	“H”	
AMT-5345	15	30	Paquete de 2 pzs

## Ornamento



**MATERIAL:** Metal

**COLOR:** Natural

**APLICACIÓN:** Decoración

MODELO	MEDIDAS – mm		PRESENTACIÓN
	“L”	“d”	
AMT-5346	60	22	Pieza

## Ornamento



**MATERIAL:** Metal

**COLOR:** Natural

**APLICACIÓN:** Decoración

MODELO	MEDIDAS – mm		PRESENTACIÓN
	“L”	“H”	
AMT-5347+48	9	22	Paquete de 1 par



## Ornamento



**MATERIAL:** Metal

**COLOR:** Natural

**APLICACIÓN:** Decoración

MODELO	MEDIDAS – mm		PRESENTACIÓN
	“L”	“H”	
AMT-5349	19	17	Paquete de 2 pzs

## Ornamento



**MATERIAL:** Metal

**COLOR:** Natural

**APLICACIÓN:** Decoración

MODELO	MEDIDAS – mm		PRESENTACIÓN
	“L”	“H”	
AMT-5350	37	27	Pieza

## Ornamento



**MATERIAL:** Metal

**COLOR:** Natural

**APLICACIÓN:** Decoración

MODELO	MEDIDAS – mm		PRESENTACIÓN
	“L”	“H”	
AMT-5351	15	22	Paquete de 2 pzs

## Ornamento



**MATERIAL:** Metal

**COLOR:** Natural

**APLICACIÓN:** Decoración

MODELO	MEDIDAS – mm		PRESENTACIÓN
	“L”	“H”	
AMT-5352-01	12	12	Paquete de 2 pzs

## Ornamento



**MATERIAL:** Metal

**COLOR:** Natural

**APLICACIÓN:** Decoración

MODELO	MEDIDAS – mm		PRESENTACIÓN
	“L”	“H”	
AMT-5352-02	12	10	Paquete de 2 pzs

## Ornamento



**MATERIAL:** Metal

**COLOR:** Natural

**APLICACIÓN:** Decoración

MODELO	MEDIDAS – mm		PRESENTACIÓN
	“L”	“H”	
AMT-5352-03	12	10	Paquete de 2 pzs

## Ornamento



**MATERIAL:** Metal

**COLOR:** Natural

**APLICACIÓN:** Decoración

MODELO	MEDIDAS – mm		PRESENTACIÓN
	“L”	“H”	
AMT-5352-04	25	6	Paquete de 2 pzs

## Ornamento

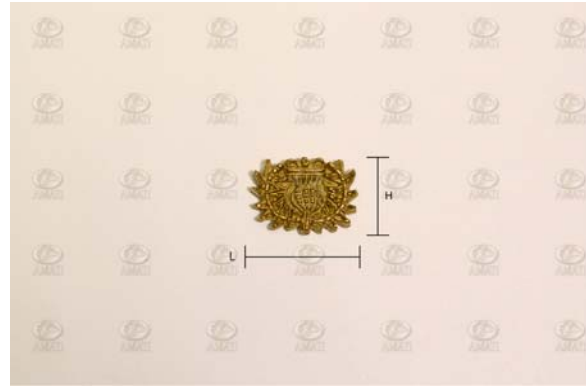

**MATERIAL:** Metal

**COLOR:** Natural

**APLICACIÓN:** Decoración

MODELO	MEDIDAS – mm		PRESENTACIÓN
	“L”	“H”	
AMT-5352-05	13	10	Paquete de 2 pzs



## Ornamento



**MATERIAL:** Metal

**COLOR:** Natural

**APLICACIÓN:** Decoración

MODELO	MEDIDAS – mm		PRESENTACIÓN
	“L”	“H”	
AMT-5352-06	15	10	Paquete de 2 pzs

## Ornamento



**MATERIAL:** Metal

**COLOR:** Natural

**APLICACIÓN:** Decoración

MODELO	MEDIDAS – mm		PRESENTACIÓN
	“L”	“H”	
AMT-5352-07	16	13	Paquete de 2 pzs

## Ornamento

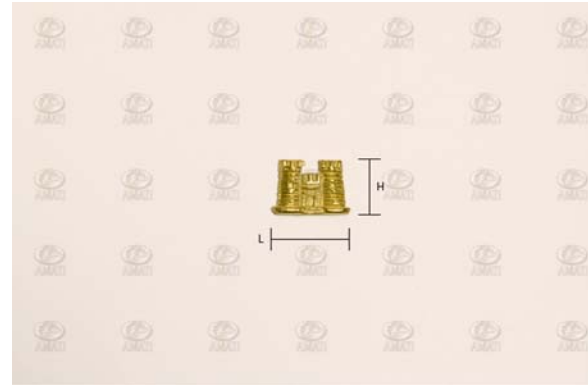

**MATERIAL:** Metal

**COLOR:** Natural

**APLICACIÓN:** Decoración

MODELO	MEDIDAS – mm		PRESENTACIÓN
	“L”	“H”	
AMT-5352-08	13	10	Paquete de 2 pzs

## Ornamento

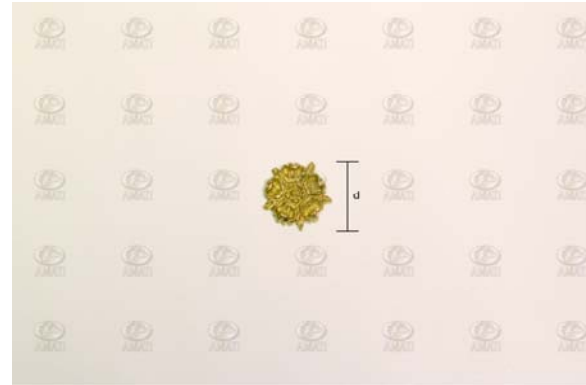

**MATERIAL:** Metal

**COLOR:** Natural

**APLICACIÓN:** Decoración

MODELO	MEDIDAS – mm	PRESENTACIÓN
	“d”	
AMT-5352-09	12	Paquete de 2 pzs

## Ornamento

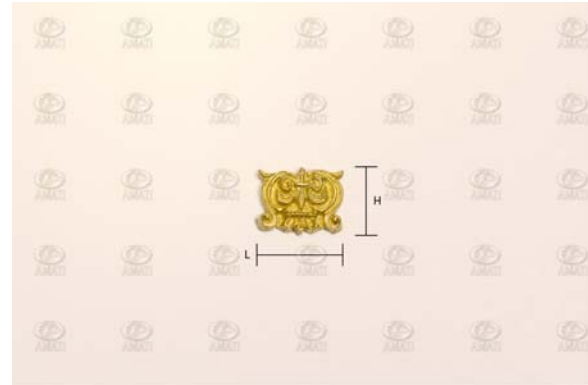

**MATERIAL:** Metal

**COLOR:** Natural

**APLICACIÓN:** Decoración

MODELO	MEDIDAS – mm		PRESENTACIÓN
	“L”	“H”	
AMT-5352-10	13	10	Paquete de 2 pzs

## Ornamento



**MATERIAL:** Metal

**COLOR:** Natural

**APLICACIÓN:** Decoración

MODELO	MEDIDAS – mm		PRESENTACIÓN
	“L”	“H”	
AMT-5352-11	13	12	Paquete de 2 pzs

## Ornamento

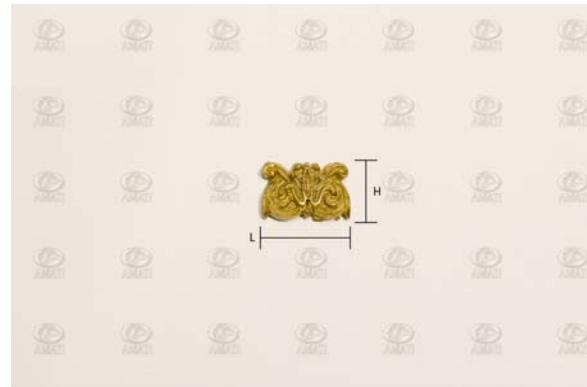

**MATERIAL:** Metal

**COLOR:** Natural

**APLICACIÓN:** Decoración

MODELO	MEDIDAS – mm		PRESENTACIÓN
	“L”	“H”	
AMT-5352-12	15	10	Paquete de 2 pzs

## Ornamento

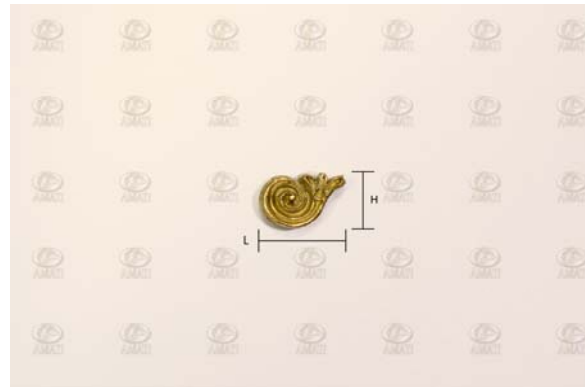

**MATERIAL:** Metal

**COLOR:** Natural

**APLICACIÓN:** Decoración

MODELO	MEDIDAS – mm		PRESENTACIÓN
	“L”	“H”	
AMT-5352-13	12	8	Paquete de 2 pzs



## Ornamento



**MATERIAL:** Metal

**COLOR:** Natural

**APLICACIÓN:** Decoración

MODELO	MEDIDAS – mm		PRESENTACIÓN
	“L”	“H”	
AMT-5352-14	12	16	Paquete de 2 pzs

## Ornamento



**MATERIAL:** Metal

**COLOR:** Natural

**APLICACIÓN:** Decoración

MODELO	MEDIDAS – mm		PRESENTACIÓN
	“L”	“H”	
AMT-5352-15+16	12	10	Paquete de 1 par

## Ornamento



**MATERIAL:** Metal

**COLOR:** Natural

**APLICACIÓN:** Decoración

MODELO	MEDIDAS – mm		PRESENTACIÓN
	“L”	“H”	
AMT-5352-17+18	10	13	Paquete de 1 par

## Ornamento



**MATERIAL:** Metal

**COLOR:** Natural

**APLICACIÓN:** Decoración

MODELO	MEDIDAS – mm		PRESENTACIÓN
	“L”	“H”	
AMT-5352-19+20	14	10	Paquete de 1 par

## Ornamento



**MATERIAL:** Metal

**COLOR:** Natural

**APLICACIÓN:** Decoración

MODELO	MEDIDAS – mm		PRESENTACIÓN
	“L”	“H”	
AMT-5352-21+22	13	10	Paquete de 1 par

## Ornamento



**MATERIAL:** Metal

**COLOR:** Natural

**APLICACIÓN:** Decoración

MODELO	MEDIDAS – mm		PRESENTACIÓN
	“L”	“H”	
AMT-5352-23+24	10	15	Paquete de 1 par

## Ornamento



**MATERIAL:** Metal

**COLOR:** Natural

**APLICACIÓN:** Decoración

MODELO	MEDIDAS – mm		PRESENTACIÓN
	“L”	“H”	
AMT-5353	7	5	Paquete de 2 pzs

## Ornamento



**MATERIAL:** Metal

**COLOR:** Natural

**APLICACIÓN:** Decoración

MODELO	MEDIDAS – mm		PRESENTACIÓN
	“L”	“H”	
AMT-5354-01	15	20	Paquete de 2 pzs



## Ornamento



**MATERIAL:** Metal

**COLOR:** Natural

**APLICACIÓN:** Decoración

MODELO	MEDIDAS – mm		PRESENTACIÓN
	“L”	“H”	
AMT-5354-02	15	20	Paquete de 2 pzs

## Ornamento



**MATERIAL:** Metal

**COLOR:** Natural

**APLICACIÓN:** Decoración

MODELO	MEDIDAS – mm		PRESENTACIÓN
	“L”	“H”	
AMT-5354-03	9	14	Paquete de 2 pzs

## Ornamento



**MATERIAL:** Metal

**COLOR:** Natural

**APLICACIÓN:** Decoración

MODELO	MEDIDAS – mm		PRESENTACIÓN
	“L”	“H”	
AMT-5354-04	22	10	Paquete de 2 pzs

## Ornamento



MATERIAL: Metal

COLOR: Natural

APLICACIÓN: Decoración

MODELO	MEDIDAS – mm			PRESENTACIÓN
	“A”	“L”	“H”	
AMT-5355-01	5	22	12	Paquete de 2 pzs

## Ornamento



**MATERIAL:** Metal

**COLOR:** Natural

**APLICACIÓN:** Decoración

MODELO	MEDIDAS – mm		PRESENTACIÓN
	“L”	“H”	
AMT-5355-02	18	22	Paquete de 2 pzs

## Ornamento



**MATERIAL:** Metal

**COLOR:** Natural

**APLICACIÓN:** Decoración

MODELO	MEDIDAS – mm		PRESENTACIÓN
	“L”	“H”	
AMT-5355-03	18	22	Paquete de 2 pzs

## Ornamento



**MATERIAL:** Metal

**COLOR:** Natural

**APLICACIÓN:** Decoración

MODELO	MEDIDAS – mm		PRESENTACIÓN
	“L”	“H”	
AMT-5355-04	18	22	Paquete de 2 pzs

## Ornamento



**MATERIAL:** Metal

**COLOR:** Natural

**APLICACIÓN:** Decoración

MODELO	MEDIDAS – mm		PRESENTACIÓN
	“L”	“H”	
AMT-5356	43	18	Pieza



## Ornamento



**MATERIAL:** Metal

**COLOR:** Natural

**APLICACIÓN:** Decoración

MODELO	MEDIDAS – mm			PRESENTACIÓN
	“A”	“L”	“H”	
AMT-5357-01	9	15	20	Paquete de 2 pzs

## Ornamento



**MATERIAL:** Metal

**COLOR:** Natural

**APLICACIÓN:** Decoración

MODELO	MEDIDAS – mm			PRESENTACIÓN
	“A”	“L”	“H”	
AMT-5357-02	9	15	20	Paquete de 2 pzs

## Ornamento



MATERIAL: Metal

COLOR: Natural

APLICACIÓN: Decoración

MODELO	MEDIDAS – mm		PRESENTACIÓN
	“L”	“H”	
AMT-5358-01+02	35	26	Paquete de 1 par

## Ornamento

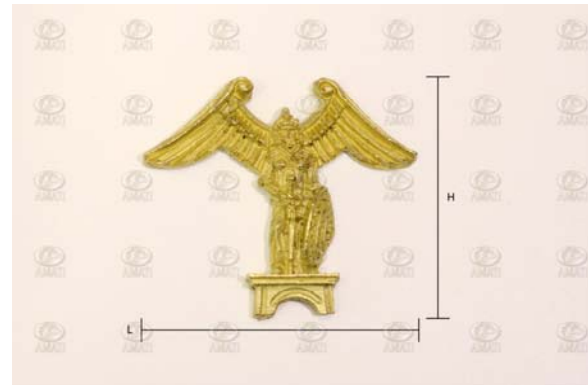

**MATERIAL:** Metal

**COLOR:** Natural

**APLICACIÓN:** Decoración

MODELO	MEDIDAS – mm		PRESENTACIÓN
	“L”	“H”	
AMT-5358-03	42	38	Pieza

## Ornamento



**MATERIAL:** Metal

**COLOR:** Natural

**APLICACIÓN:** Decoración

MODELO	MEDIDAS – mm		PRESENTACIÓN
	“L”	“H”	
AMT-5359	15	12	Paquete de 2 pzs

## Ornamento

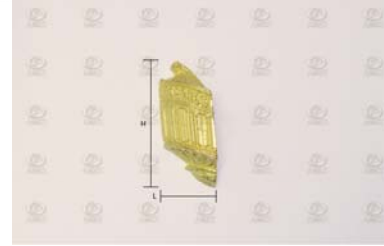
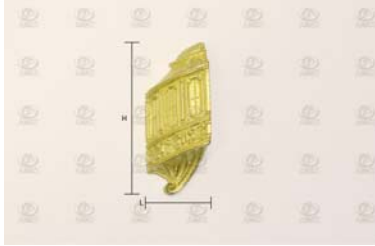

**MATERIAL:** Metal

**COLOR:** Natural

**ACABADO:** Envejecido

MODELO	MEDIDAS – mm			PRESENTACIÓN
	“A”	“L”	“H”	
AMT-5360-01+02	10	18	40	Paquete de 1 par

## Ornamento



**MATERIAL:** Metal

**COLOR:** Natural

**APLICACIÓN:** Decoración

MODELO	MEDIDAS – mm		PRESENTACIÓN
	“L”	“H”	
AMT-5361-01+02	15	30	Paquete de 1 par

## Ornamento



**MATERIAL:** Metal

**COLOR:** Natural

**APLICACIÓN:** Decoración

MODELO	MEDIDAS – mm		PRESENTACIÓN
	“L”	“H”	
AMT-5362-01	55	15	Paquete de 2 pzs



## Ornamento



**MATERIAL:** Metal

**COLOR:** Natural

**APLICACIÓN:** Decoración

MODELO	MEDIDAS – mm			PRESENTACIÓN
	“A”	“L”	“H”	
AMT-5362-02	6	90	15	Paquete de 2 pzs

## Ornamento



**MATERIAL:** Metal

**COLOR:** Natural

**APLICACIÓN:** Decoración

MODELO	MEDIDAS – mm		PRESENTACIÓN
	“L”	“H”	
AMT-5362-03	43	13	Paquete de 2 pzs

## Ornamento



**MATERIAL:** Metal

**COLOR:** Natural

**APLICACIÓN:** Decoración

MODELO	MEDIDAS – mm			PRESENTACIÓN
	“L”	“L1”	“H”	
AMT-5363	50	42	28	Pieza

## Ornamento



**MATERIAL:** Metal

**COLOR:** Natural

**APLICACIÓN:** Decoración

MODELO	MEDIDAS – mm		PRESENTACIÓN
	“L”	“H”	
AMT-5364	40	10	Pieza

## Ornamento



**MATERIAL:** Metal

**COLOR:** Natural

**APLICACIÓN:** Decoración

MODELO	MEDIDAS – mm		PRESENTACIÓN
	“L”	“H”	
AMT-5365-01+02	15	30	Paquete de 1 par

## Ornamento



**MATERIAL:** Metal

**COLOR:** Natural

**APLICACIÓN:** Decoración

MODELO	MEDIDAS – mm		PRESENTACIÓN
	“L”	“H”	
AMT-5366-01	13	17	Paquete de 2 pzs

## Ornamento



**MATERIAL:** Metal

**COLOR:** Natural

**APLICACIÓN:** Decoración

MODELO	MEDIDAS – mm		PRESENTACIÓN
	“L”	“H”	
AMT-5366-02	13	17	Paquete de 2 pzs

## Ornamento



**MATERIAL:** Metal

**COLOR:** Natural

**APLICACIÓN:** Decoración

MODELO	MEDIDAS – mm	PRESENTACIÓN
	“L”	
AMT-5500-01	250	Paquete de 2 pzs



## Ornamento

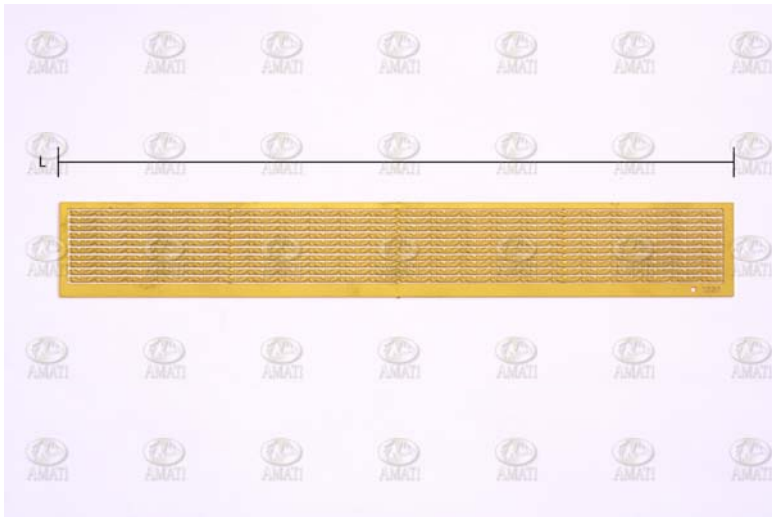

**MATERIAL:** Metal

**COLOR:** Natural

**APLICACIÓN:** Decoración

MODELO	MEDIDAS – mm	PRESENTACIÓN
	“L”	
AMT-5500-02	250	Paquete de 2 pzs

## Ornamento



**MATERIAL:** Metal

**COLOR:** Natural

**APLICACIÓN:** Decoración

MODELO	MEDIDAS – mm	PRESENTACIÓN
	“L”	
AMT-5500-03	250	Paquete de 2 pzs

## Ornamento



**MATERIAL:** Metal

**COLOR:** Natural

**APLICACIÓN:** Decoración

MODELO	MEDIDAS – mm	PRESENTACIÓN
	“L”	
AMT-5500-04	250	Paquete de 2 pzs

## Ornamento



**MATERIAL:** Metal

**COLOR:** Natural

**APLICACIÓN:** Decoración

MODELO	MEDIDAS – mm	PRESENTACIÓN
	“L”	
AMT-5500-05	250	Paquete de 2 pzs

## Ornamento



MATERIAL: Metal

COLOR: Natural

APLICACIÓN: Decoración

MODELO	MEDIDAS – mm	PRESENTACIÓN
	“L”	
AMT-5500-06	250	Paquete de 2 pzs

## Ornamento

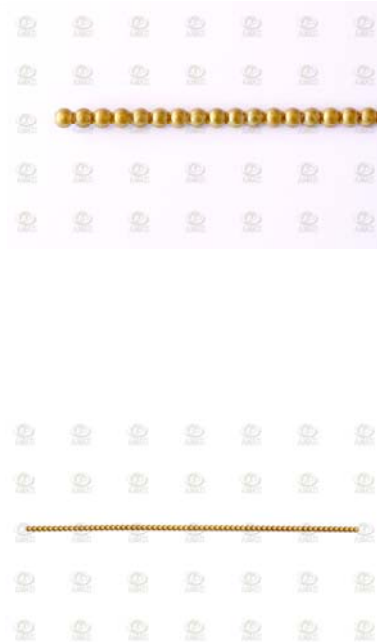

**MATERIAL:** Metal

**COLOR:** Natural

**APLICACIÓN:** Decoración

MODELO	MEDIDAS – mm	PRESENTACIÓN
	“L”	
AMT-5500-07	250	Paquete de 2 pzs

## Ornamento



**MATERIAL:** Metal

**COLOR:** Natural

**APLICACIÓN:** Decoración

MODELO	MEDIDAS – mm	PRESENTACIÓN
	“L”	
AMT-5500-08	250	Paquete de 2 pzs

## Ornamento



MATERIAL: Metal

COLOR: Natural

APLICACIÓN: Decoración

MODELO	MEDIDAS – mm	PRESENTACIÓN
	“L”	
AMT-5500-09	250	Paquete de 2 pzs



## Ornamento

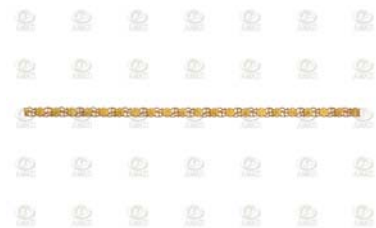

MATERIAL: Metal  
 COLOR: Natural  
 APLICACIÓN: Decoración

MODELO	MEDIDAS – mm	PRESENTACIÓN
	“L”	
AMT-5500-10	250	Paquete de 2 pzs

## Ornamento



MATERIAL: Metal

COLOR: Natural

APLICACIÓN: Decoración

MODELO	MEDIDAS – mm	PRESENTACIÓN
	“L”	
AMT-5500-11	250	Paquete de 2 pzs

## Ornamento

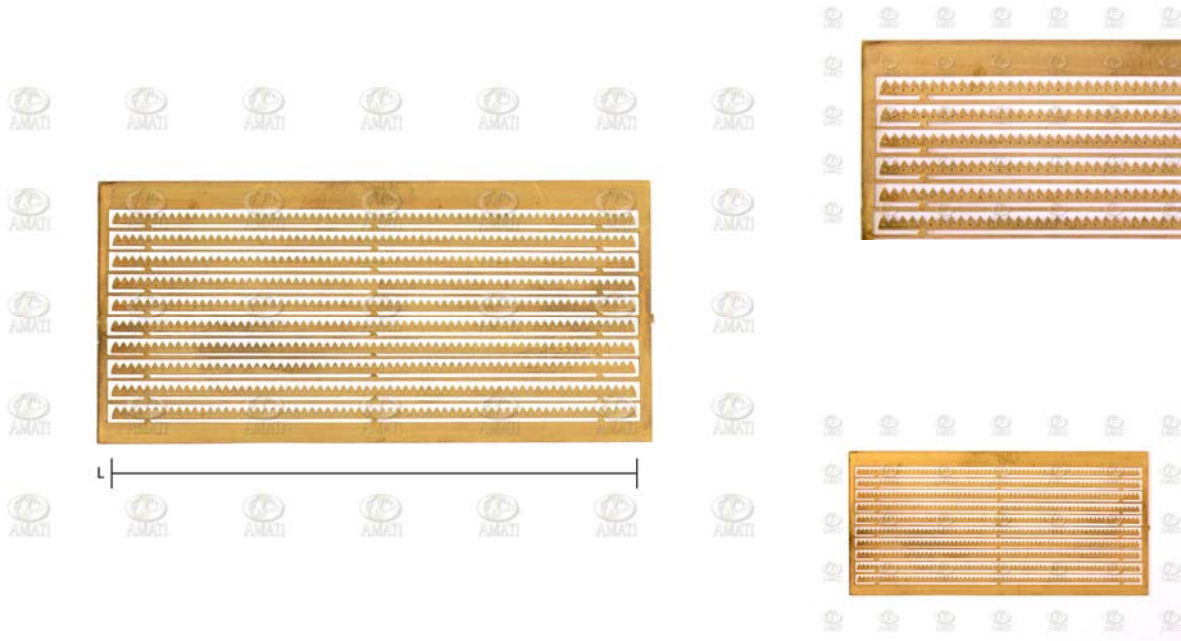

MATERIAL: Metal

COLOR: Natural

APLICACIÓN: Decoración

MODELO	MEDIDAS – mm	PRESENTACIÓN
	“L”	
AMT-5500-12	130	Paquete de 2 pzs

## Ornamento



**MATERIAL:** Metal

**COLOR:** Natural

**APLICACIÓN:** Decoración

MODELO	MEDIDAS – mm		PRESENTACIÓN
	“L”	“H”	
AMT-5530-01	28	15	Paquete de 20 pzs

## Ornamento



**MATERIAL:** Metal

**COLOR:** Natural

**APLICACIÓN:** Decoración

MODELO	MEDIDAS – mm	PRESENTACIÓN
	“d”	
AMT-5530-03	22	Paquete de 10 pzs

## Ornamento



**MATERIAL:** Metal

**COLOR:** Natural

**APLICACIÓN:** Decoración

MODELO	MEDIDAS – mm		PRESENTACIÓN
	“L”	“H”	
AMT-5530-06	6	15	Paquete de 10 pzs

## Ornamento



**MATERIAL:** Metal

**COLOR:** Natural

**APLICACIÓN:** Decoración

MODELO	MEDIDAS – mm		PRESENTACIÓN
	“L”	“H”	
AMT-5530-07	20	10	Paquete de 10 pzs

## Ornamento



MATERIAL: Metal

COLOR: Natural

APLICACIÓN: Decoración

MODELO	MEDIDAS – mm			PRESENTACIÓN
	“H”	“d”	“d1”	
AMT-5530-08	4	5	4	Paquete de 10 pzs



## Ornamento



**MATERIAL:** Metal

**COLOR:** Natural

**APLICACIÓN:** Decoración

MODELO	MEDIDAS – mm			PRESENTACIÓN
	“H”	“d”	“d1”	
AMT-5530-09	5	13	5	Paquete de 10 pzs

## Ornamento



**MATERIAL:** Metal

**COLOR:** Natural

**APLICACIÓN:** Decoración

MODELO	MEDIDAS – mm			PRESENTACIÓN
	“H”	“d”	“d1”	
AMT-5530-10	4	20	7	Paquete de 10 pzs

## Ornamento



**MATERIAL:** Metal

**COLOR:** Natural

**APLICACIÓN:** Decoración

MODELO	MEDIDAS – mm		PRESENTACIÓN
	“L”	“H”	
AMT-5530-12	10	13	Paquete de 20 pzs

## Ornamento



**MATERIAL:** Metal

**COLOR:** Natural

**APLICACIÓN:** Decoración

MODELO	MEDIDAS – mm		PRESENTACIÓN
	“L”	“H”	
AMT-5530-13	17	21	Paquete de 20 pzs

## Ornamento



**MATERIAL:** Metal

**COLOR:** Natural

**APLICACIÓN:** Decoración

MODELO	MEDIDAS – mm		PRESENTACIÓN
	“d”	“d1”	
AMT-5530-14	13	6	Paquete de 10 pzs

## Ornamento



**MATERIAL:** Metal

**COLOR:** Natural

**APLICACIÓN:** Decoración

MODELO	MEDIDAS – mm		PRESENTACIÓN
	“d”	“d1”	
AMT-5530-15	8	5	Paquete de 20 pzs

## Ornamento



**MATERIAL:** Metal

**COLOR:** Natural

**APLICACIÓN:** Decoración

MODELO	MEDIDAS – mm		PRESENTACIÓN
	“d”	“d1”	
AMT-5530-16	13	8	Paquete de 20 pzs

## Ornamento



**MATERIAL:** Metal

**COLOR:** Natural

**APLICACIÓN:** Decoración

MODELO	MEDIDAS – mm	PRESENTACIÓN
	“d”	
AMT-5530-21	4	Paquete de 20 pzs



## Ornamento



**MATERIAL:** Metal

**COLOR:** Natural

**APLICACIÓN:** Decoración

MODELO	MEDIDAS – mm	PRESENTACIÓN
	“d”	
AMT-5530-22	8	Paquete de 20 pzs

## Ornamento



**MATERIAL:** Metal

**COLOR:** Natural

**APLICACIÓN:** Decoración

MODELO	MEDIDAS – mm	PRESENTACIÓN
	“d”	
AMT-5530-23	10	Paquete de 20 pzs

## Ornamento



**MATERIAL:** Metal

**COLOR:** Natural

**APLICACIÓN:** Decoración

MODELO	MEDIDAS – mm	PRESENTACIÓN
	“L”	
AMT-5530-24	5	Paquete de 20 pzs
AMT-5530-25	8	Paquete de 20 pzs

## Ornamento



**MATERIAL:** Metal

**COLOR:** Natural

**APLICACIÓN:** Decoración

MODELO	MEDIDAS – mm	PRESENTACIÓN
	“d”	
AMT-5530-26	8	Paquete de 20 pzs

## Ornamento



MATERIAL: Metal

COLOR: Natural

APLICACIÓN: Decoración

MODELO	MEDIDAS – mm		PRESENTACIÓN
	“L”	“H”	
AMT-5530-27	4	5	Paquete de 50 pzs

## Ornamento



**MATERIAL:** Metal

**COLOR:** Natural

**APLICACIÓN:** Decoración

MODELO	MEDIDAS – mm		PRESENTACIÓN
	“L”	“H”	
AMT-5530-29	22	30	Paquete de 2 pzs

## Ornamento

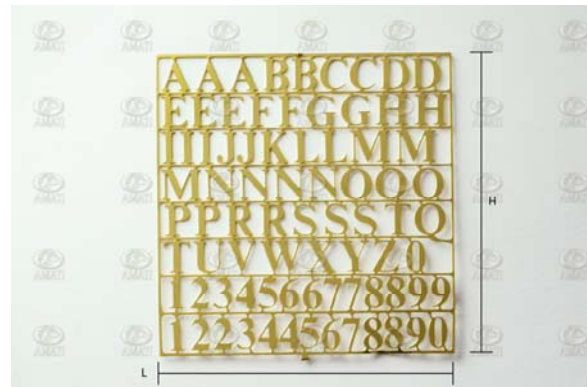

**MATERIAL:** Metal

**COLOR:** Natural

**APLICACIÓN:** Decoración

MODELO	MEDIDAS – mm		PRESENTACIÓN
	“L”	“H”	
AMT-5650-01	58	60	Pieza
AMT-5650-02	95	98	Pieza

## Base para barco



**MATERIAL:** Madera de nogal

**COLOR:** Natural

**APLICACIÓN:** Pedestal para colocar los barcos sobre la base

MODELO	MEDIDAS – mm		PRESENTACIÓN
	“H”	“d”	
AMT-5685	65	25	Paquete de 2 pzs



## Base para barco



**MATERIAL:** Madera de balsa

**COLOR:** Natural

**APLICACIÓN:** Pedestal para colocar los barcos sobre la base

MODELO	MEDIDAS – mm		PRESENTACIÓN
	“H”	“d”	
AMT-5685-02	28	20	Paquete de 2 pzs

## Base para barco



**MATERIAL:** Madera de nogal

**COLOR:** Natural

**APLICACIÓN:** Pedestal para colocar los barcos sobre la base

MODELO	MEDIDAS – mm		PRESENTACIÓN
	“H”	“d”	
AMT-5685-03	32	30	Paquete de 2 pzs

## Base para barco



**MATERIAL:** Madera de nogal

**COLOR:** Natural

**APLICACIÓN:** Pedestal para colocar los barcos sobre la base

MODELO	MEDIDAS – mm		PRESENTACIÓN
	“H”	“d”	
AMT-5685-04	50	30	Paquete de 2 pzs

## Base para barco



**MATERIAL:** Latón

**COLOR:** Natural

**APLICACIÓN:** Pedestal para colocar los barcos sobre la base

MODELO	MEDIDAS – mm		PRESENTACIÓN
	“H”	“d”	
AMT-5690-26	26	13	Paquete de 2 pzs

## Base para barco



**MATERIAL:** Latón

**COLOR:** Natural

**APLICACIÓN:** Pedestal para colocar los barcos sobre la base

MODELO	MEDIDAS – mm		PRESENTACIÓN
	“H”	“d”	
AMT-5690-29	29	15	Paquete de 2 pzs

## Base para barco



**MATERIAL:** Latón

**COLOR:** Natural

**APLICACIÓN:** Pedestal para colocar los barcos sobre la base

MODELO	MEDIDAS – mm		PRESENTACIÓN
	“H”	“d”	
AMT-5690-35	35	18	Paquete de 2 pzs

## Marineros



**MATERIAL:** Metal

**COLOR:** Natural

**APLICACIÓN:** Decoración

MODELO	MEDIDAS – mm	PRESENTACIÓN
	“H”	
AMT-8000-01+04	23	Kit de 5 pzs

## Marineros



**MATERIAL:** Metal

**COLOR:** Natural

**APLICACIÓN:** Decoración

MODELO	MEDIDAS – mm	PRESENTACIÓN
	“H”	
AMT-8000-01+04	23	Kit de 5 pzs



## Marineros



**MATERIAL:** Metal

**COLOR:** Natural

**APLICACIÓN:** Decoración

MODELO	MEDIDAS – mm	PRESENTACIÓN
	“H”	
AMT-8000-01+04	23	Kit de 5 pzs

## Marineros



**MATERIAL:** Metal

**COLOR:** Natural

**APLICACIÓN:** Decoración

MODELO	MEDIDAS – mm	PRESENTACIÓN
	“H”	
AMT-8000-01+04	23	Kit de 5 pzs

## Marineros



**MATERIAL:** Metal

**COLOR:** Natural

**APLICACIÓN:** Decoración

MODELO	MEDIDAS – mm	PRESENTACIÓN
	“H”	
AMT-8000-01+04	17	Kit de 5 pzs

## Marineros



**MATERIAL:** Metal

**COLOR:** Natural

**APLICACIÓN:** Decoración

MODELO	MEDIDAS – mm	PRESENTACIÓN
	“H”	
AMT-8005-01+06	27	Kit de 6 pzs

## Marineros



**MATERIAL:** Metal

**COLOR:** Natural

**APLICACIÓN:** Decoración

MODELO	MEDIDAS – mm	PRESENTACIÓN
	“H”	
AMT-8005-01+06	25	Kit de 6 pzs

## Marineros



**MATERIAL:** Metal

**COLOR:** Natural

**APLICACIÓN:** Decoración

MODELO	MEDIDAS – mm	PRESENTACIÓN
	“H”	
AMT-8005-01+06	23	Kit de 6 pzs

## Marineros



**MATERIAL:** Metal

**COLOR:** Natural

**APLICACIÓN:** Decoración

MODELO	MEDIDAS – mm	PRESENTACIÓN
	“H”	
AMT-8005-01+06	13	Kit de 6 pzs

## Marineros



**MATERIAL:** Metal

**COLOR:** Natural

**APLICACIÓN:** Decoración

MODELO	MEDIDAS – mm	PRESENTACIÓN
	“H”	
AMT-8005-01+06	29	Kit de 6 pzs



## Marineros



**MATERIAL:** Metal

**COLOR:** Natural

**APLICACIÓN:** Decoración

MODELO	MEDIDAS – mm	PRESENTACIÓN
	“H”	
AMT-8005-01+06	25	Kit de 6 pzs

## Marineros



**MATERIAL:** Metal

**COLOR:** Natural

**APLICACIÓN:** Decoración

MODELO	MEDIDAS – mm	PRESENTACIÓN
	“H”	
AMT-8008-01+06	34	Kit de 6 pzs

## Marineros



**MATERIAL:** Metal

**COLOR:** Natural

**APLICACIÓN:** Decoración

MODELO	MEDIDAS – mm	PRESENTACIÓN
	“H”	
AMT-8008-01+06	33	Kit de 6 pzs

## Marineros



**MATERIAL:** Metal

**COLOR:** Natural

**APLICACIÓN:** Decoración

MODELO	MEDIDAS – mm	PRESENTACIÓN
	“H”	
AMT-8008-01+06	33	Kit de 6 pzs

## Marineros



**MATERIAL:** Metal

**COLOR:** Natural

**APLICACIÓN:** Decoración

MODELO	MEDIDAS – mm	PRESENTACIÓN
	“H”	
AMT-8008-01+06	32	Kit de 6 pzs

## Marineros



**MATERIAL:** Metal

**COLOR:** Natural

**APLICACIÓN:** Decoración

MODELO	MEDIDAS – mm	PRESENTACIÓN
	“H”	
AMT-8008-01+06	31	Kit de 6 pzs

## Marineros



**MATERIAL:** Metal

**COLOR:** Natural

**APLICACIÓN:** Decoración

MODELO	MEDIDAS – mm	PRESENTACIÓN
	“H”	
AMT-8008-01+06	35	Kit de 6 pzs